

Utensili necessari / Tools needed

Indossare guanti di protezione
Wear protective gloves

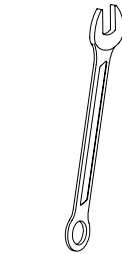

CH 18

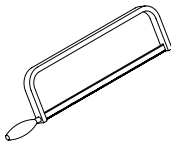
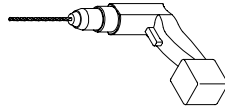
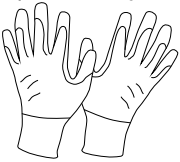
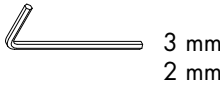

3 mm
2 mm



ATTENZIONE!!!!

Tutte le operazioni di installazione e manutenzione richiedono l'ausilio di NR. 2 OPERATORI SPECIALIZZATI

WARNING!!!!

All installation and maintenance operations require 2 QUALIFIED WORKER

- LEGGERE ATTENTAMENTE LE ISTRUZIONI PRIMA DI INSTALLARE IL SOFFIONE
- PLEASE READ CAREFULLY THE FOLLOWING INSTRUCTIONS BEFORE INSTALLING THE SHOWERHEAD

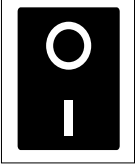

Interruttore on/off
Control key on/off

Alimentatore: Non installare
nelle zone 0, 1 e 2
Feeder: do not install in the
areas 0, 1 and 2

Cavo Doccia 12Vcc (5 mt.)
Shower cable 12 Vcc (5 mt.)

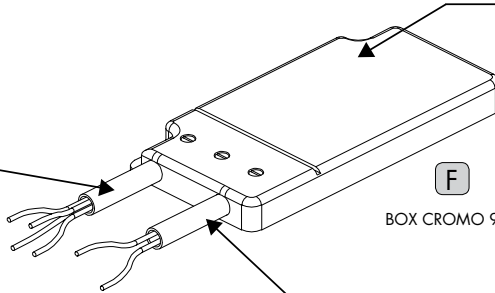

BOX CROMO 9

Cavo 220Vac (non fornito)
Cable 220 Vac (not provided)

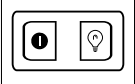

Pulsantiera accensione luci
Remote control light switch

Alimentatore: Non installare
nelle zone 0, 1 e 2
Feeder: do not install in the
areas 0, 1 and 2

Cavo Doccia 12Vcc (5 mt.)
Shower cable 12 Vcc (5 mt.)

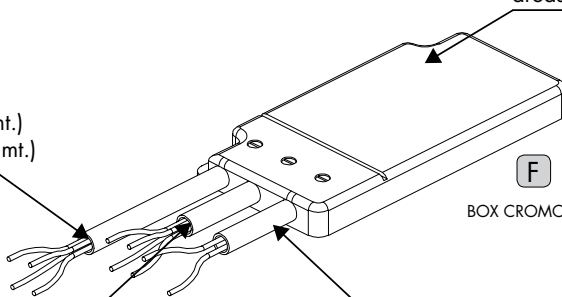

BOX CROMO 9

Cavo pulsantiera
12Vcc (20 cm.)
Cable remote control
12Vcc (20 cm.)

Cavo 220Vac (non fornito)
Cable 220 Vac (not provided)

PRESA ACQUA
WATER FEED

Posizionare 1 Trasformatore all'esterno della zona 2 (nella zona 3)
Place the current transformer outside area 2 (inside area 3)

interruttore per alimentazione.
Non in dotazione.
Light ON/OFF switch. Not provided.

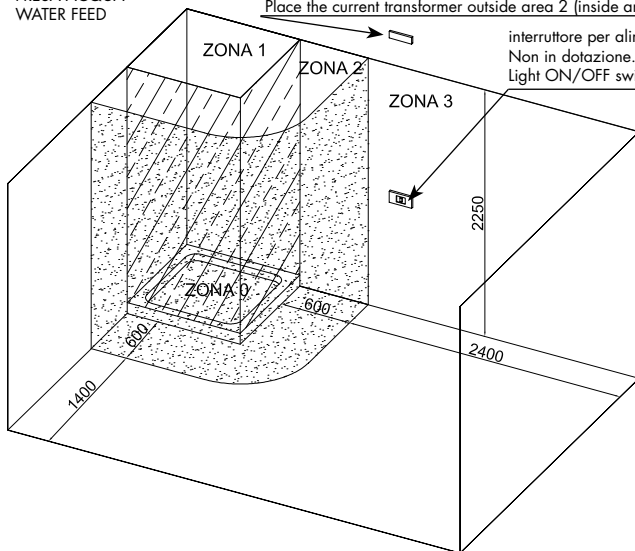

Per tutte le versioni dei soffioni è necessaria l'installazione di un interruttore ON/OFF sull'alimentazione del trasformatore.
All false ceiling shower heads require installation of control key for switch on/off lights on transformer power supply.



All'interno delle zone ZONA 0 - ZONA 1 - ZONA 2
NON DEVE ESSERE MAI PRESENTE LA TENSIONE 220V
ELECTRICAL CURRENT AT 220 V MUST NEVER BE PRESENT within areas 0 - 1 - and 2

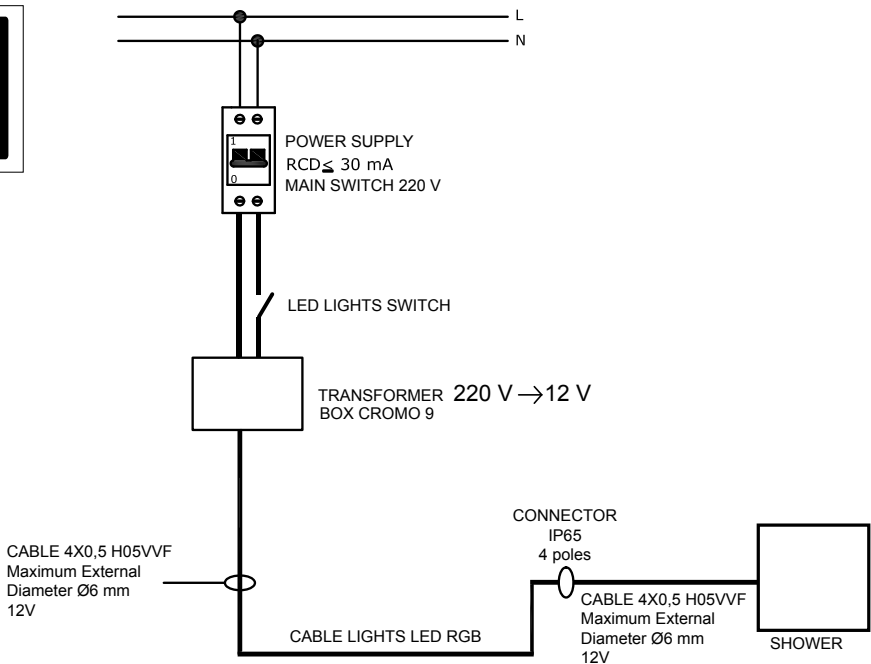
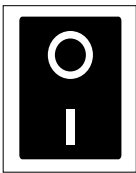
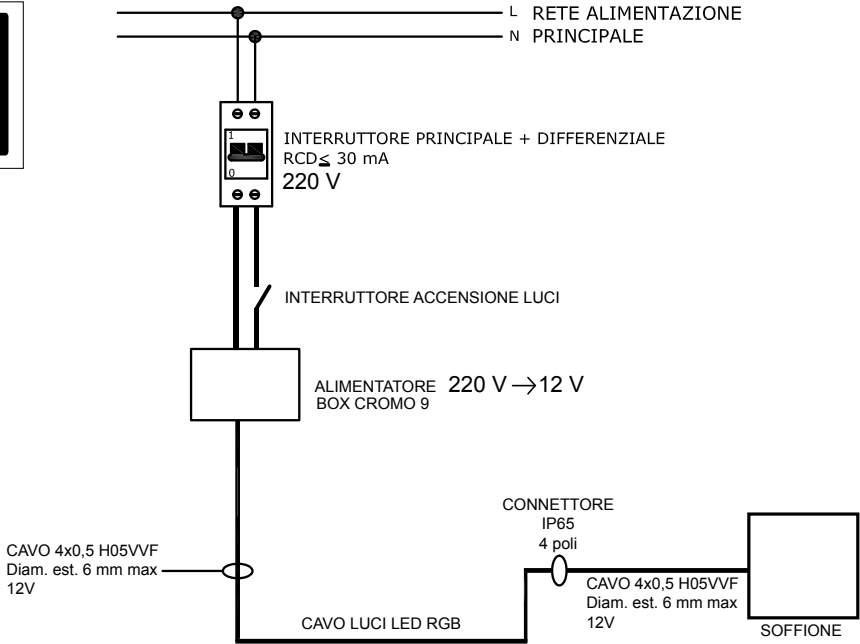
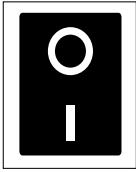

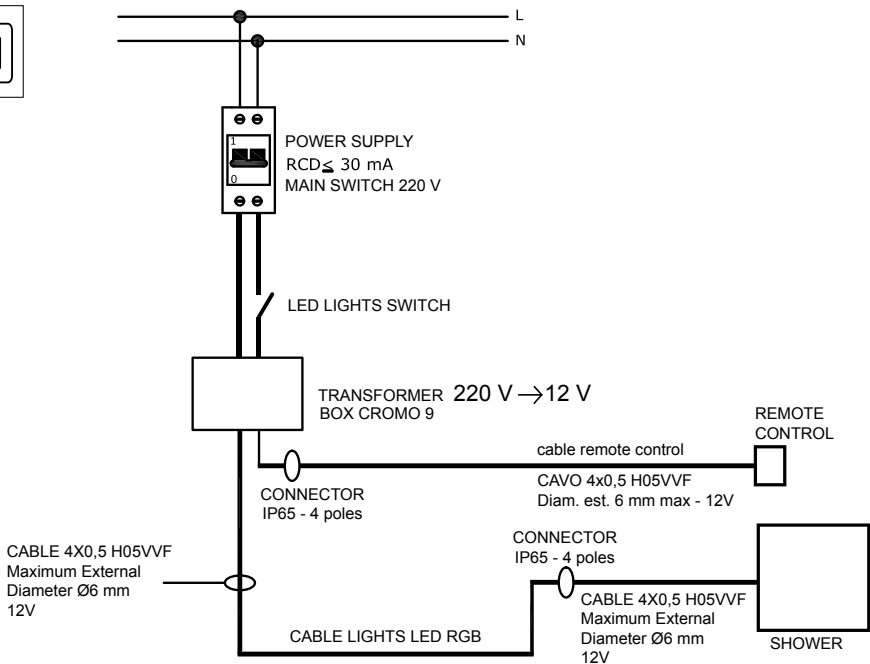
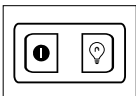
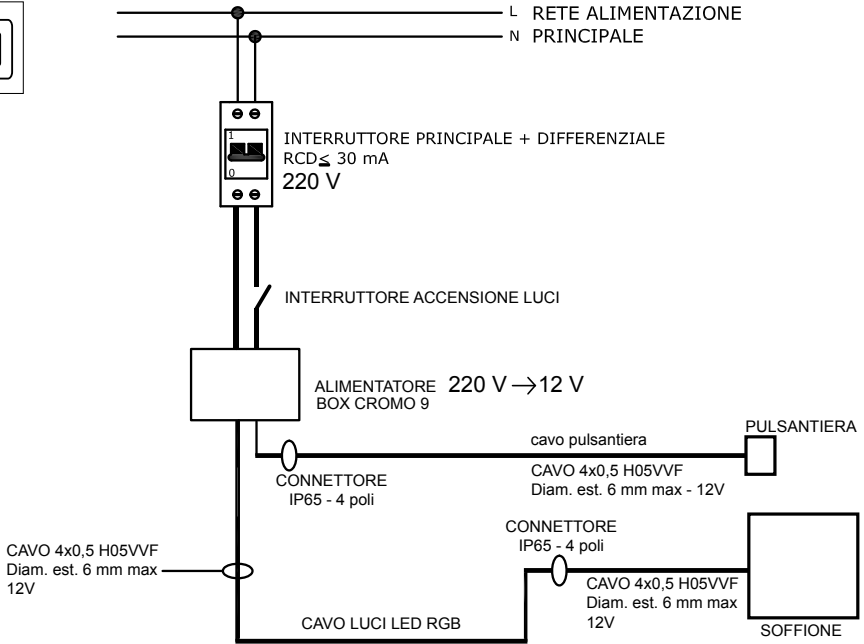
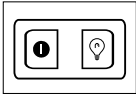

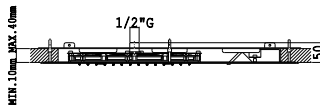
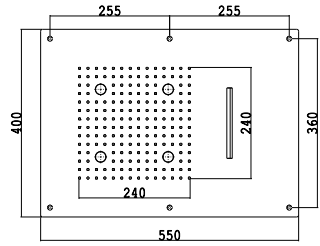
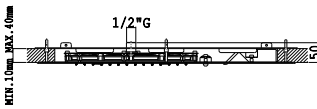
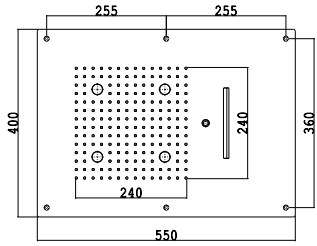
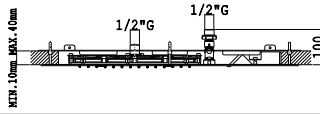
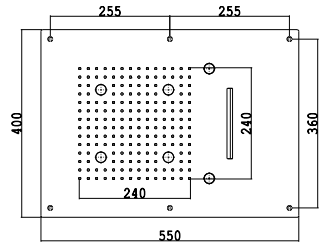
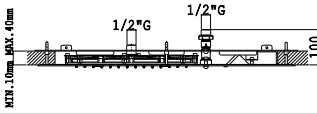
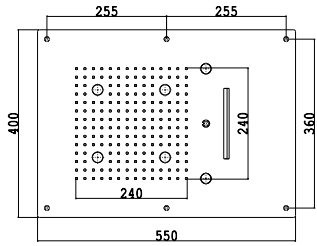



x = 510 mm.
Y = 310 mm.
z = min 160 mm. / max 700 mm.

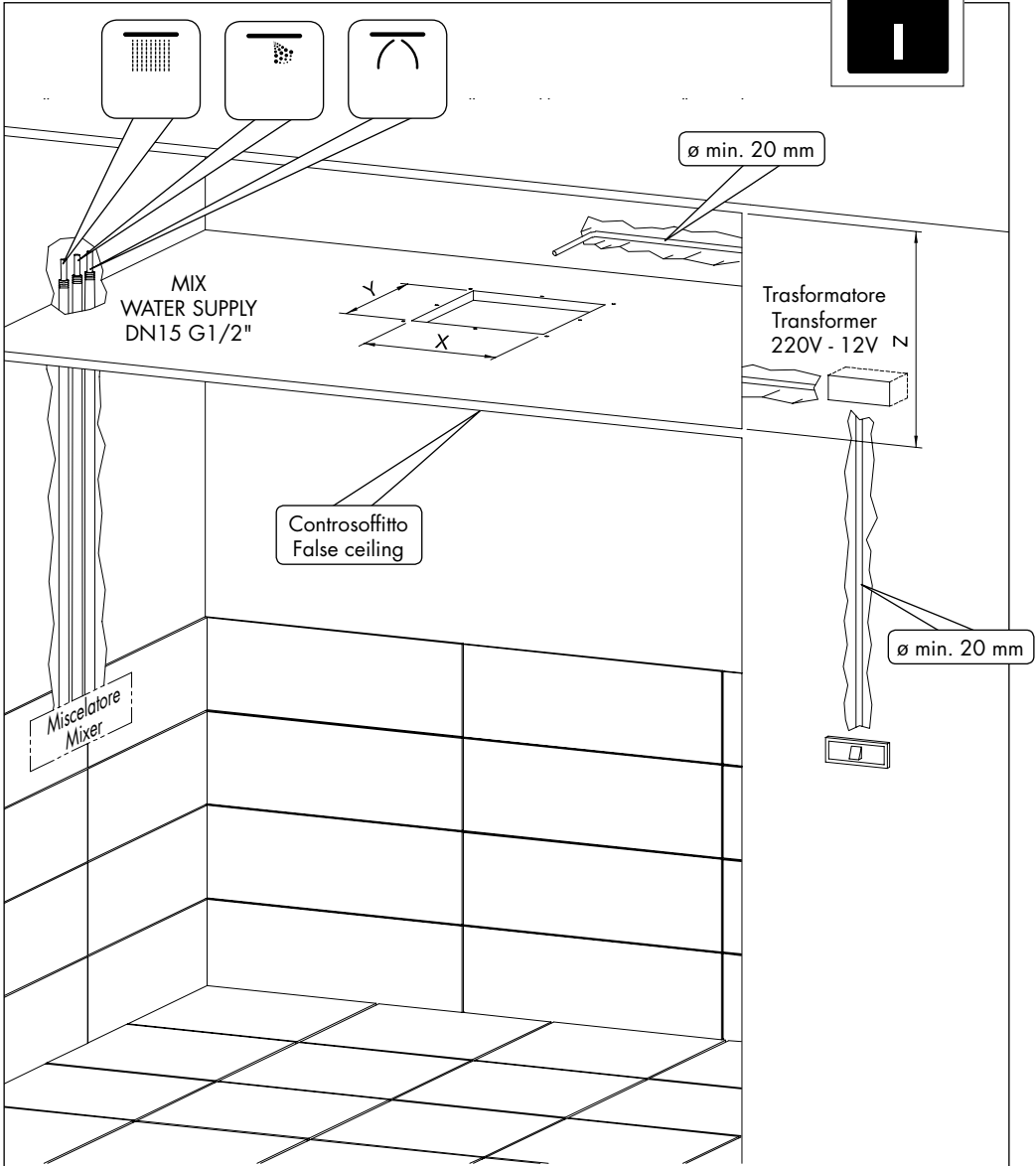
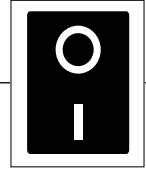



x = 510 mm.
Y = 310 mm.
z = min 160 mm. / max 700 mm.

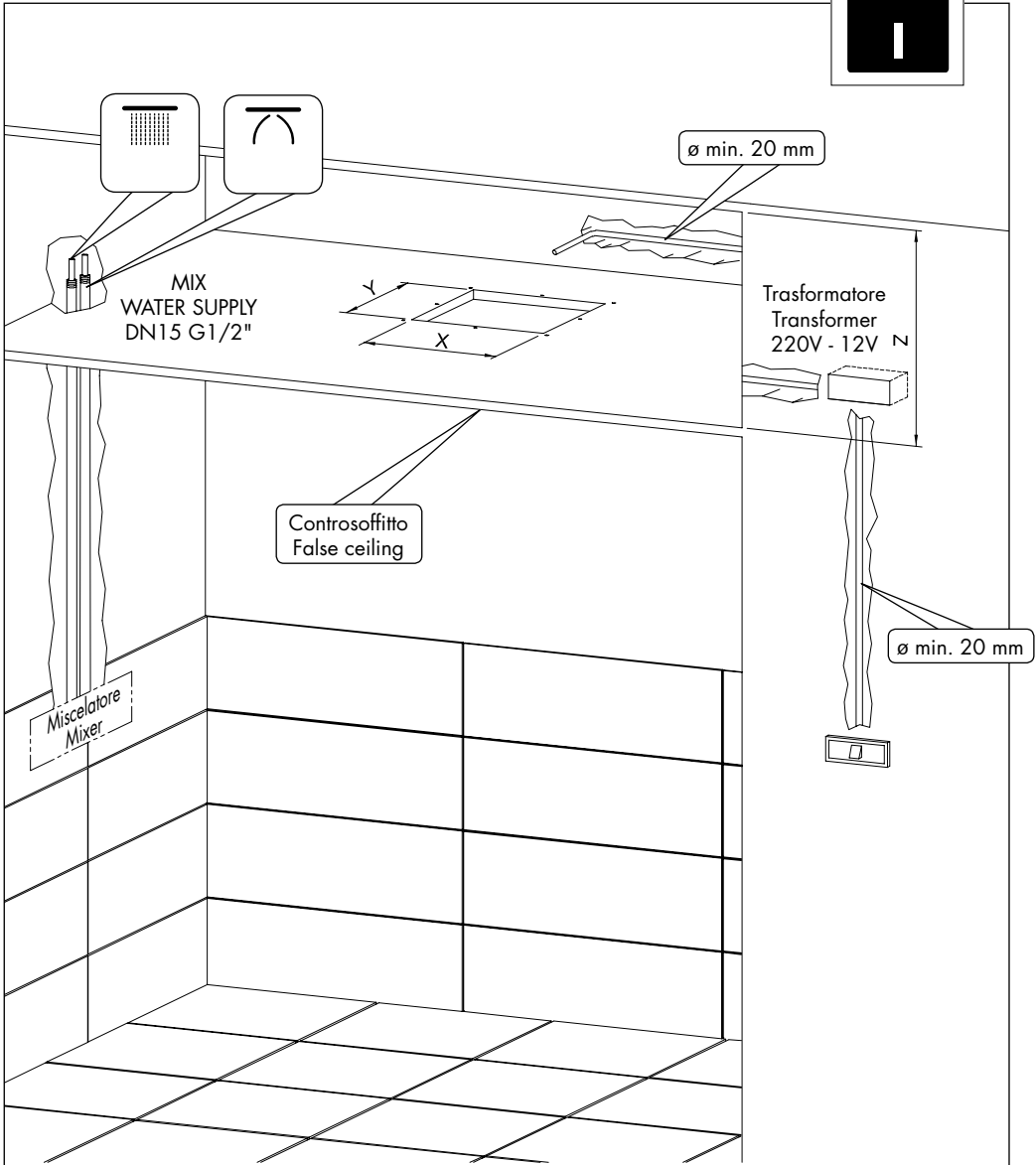
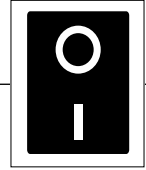

Schema impianto idraulico-elettrico / Hydraulic-electric system layout



x = 510 mm.
Y = 310 mm.
z = min 160 mm. / max 700 mm.

Per tutte le versioni dei soffioni è necessaria l'installazione di un interruttore ON/OFF sull'alimentazione del trasformatore.
All false ceiling shower heads require installation of control key for switch on/off lights on transformer power supply.

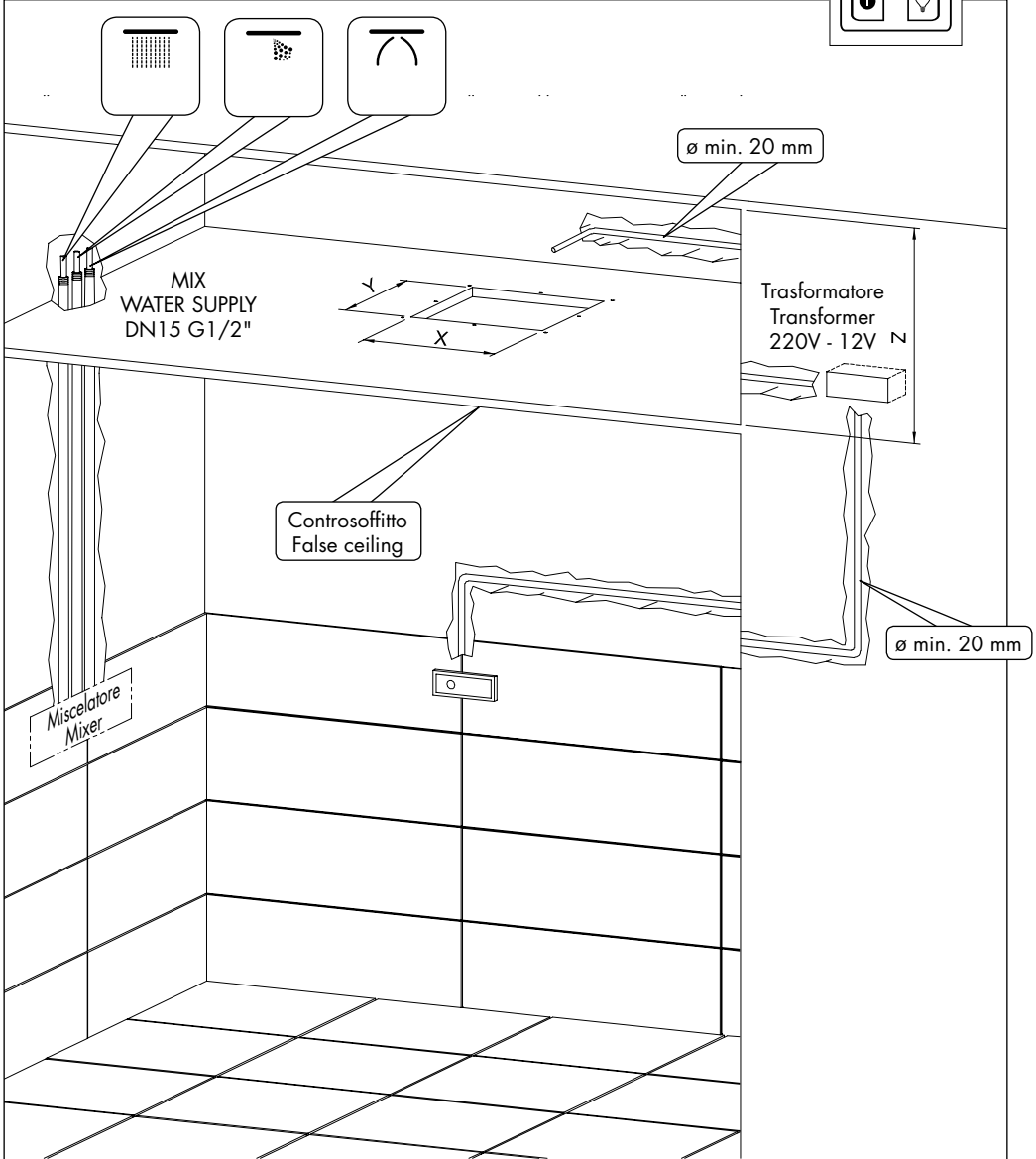

Schema impianto idraulico-elettrico / Hydraulic-electric system layout



x = 510 mm.
Y = 310 mm.
z = min 160 mm. / max 700 mm.

Per tutte le versioni dei soffioni è necessaria l'installazione di un interruttore ON/OFF sull'alimentazione del trasformatore.
All false ceiling shower heads require installation of control key for switch on/off lights on transformer power supply.

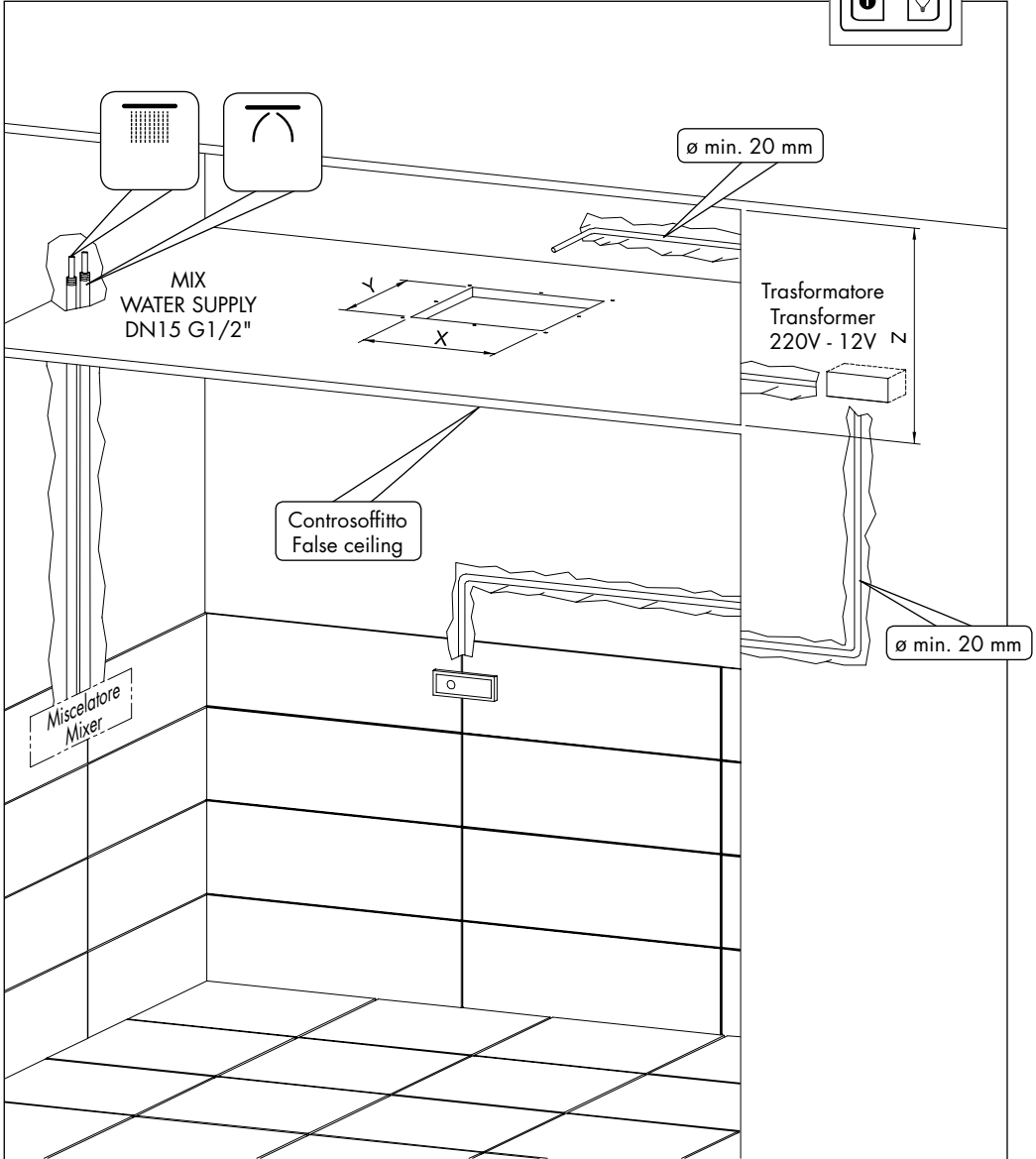

a

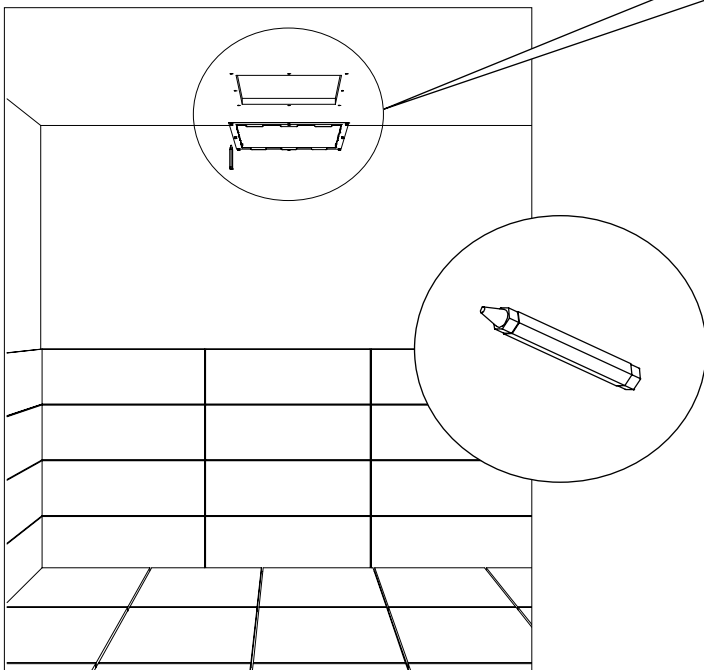
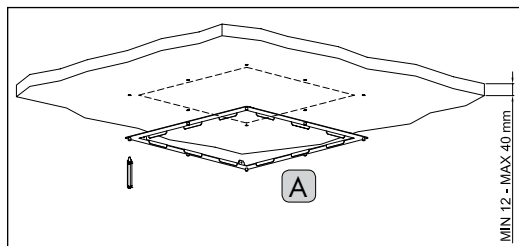

b

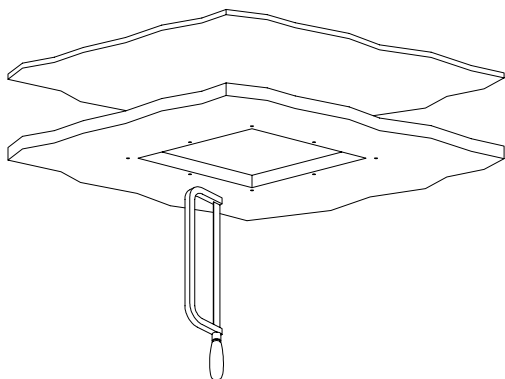

c

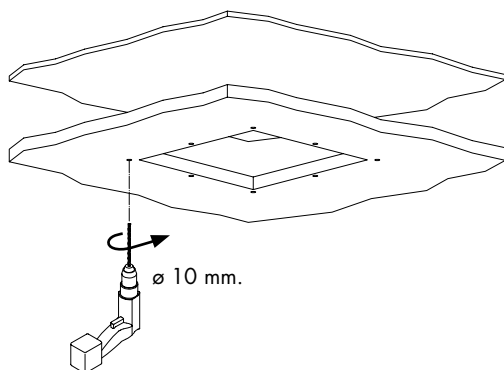

d

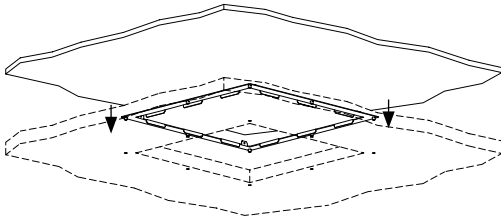

e

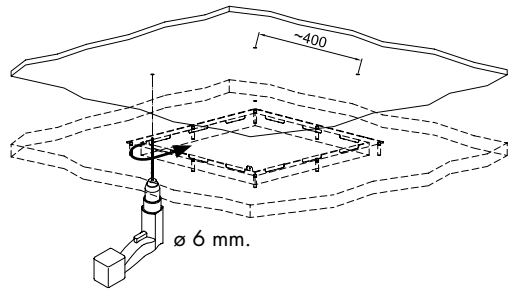

f

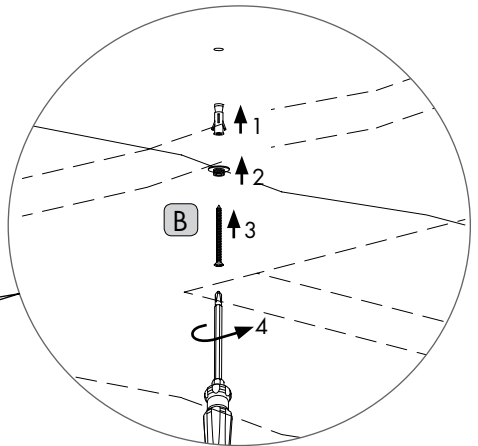
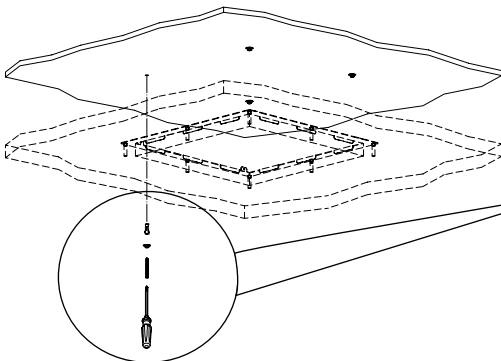

g

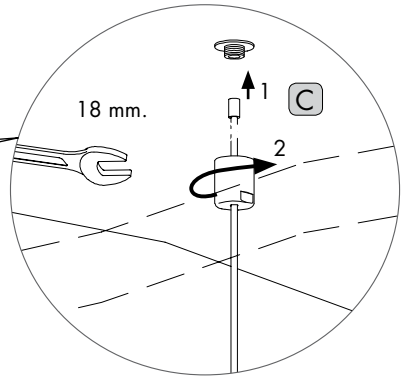
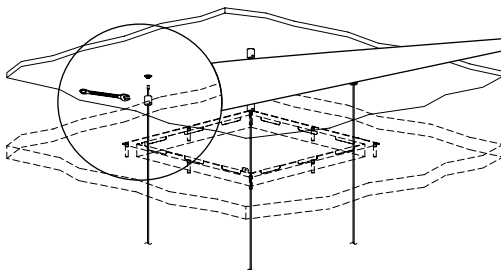

h

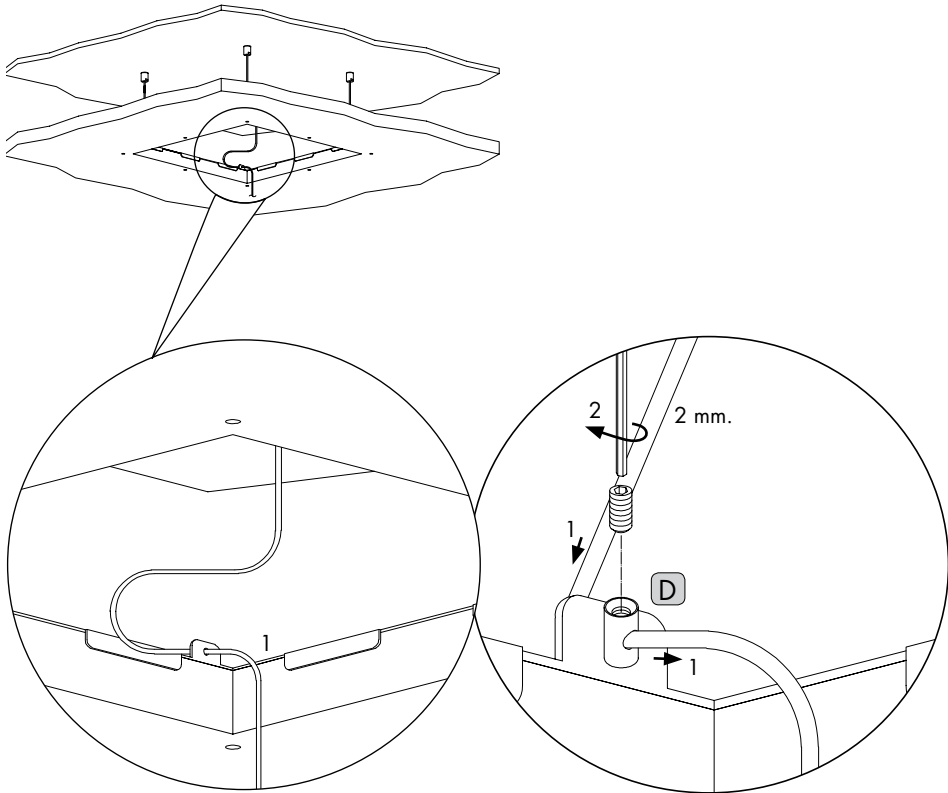

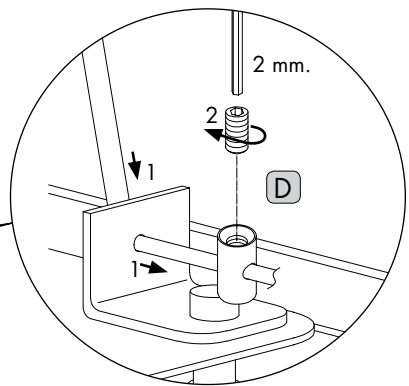
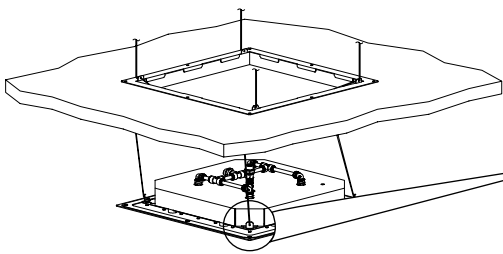
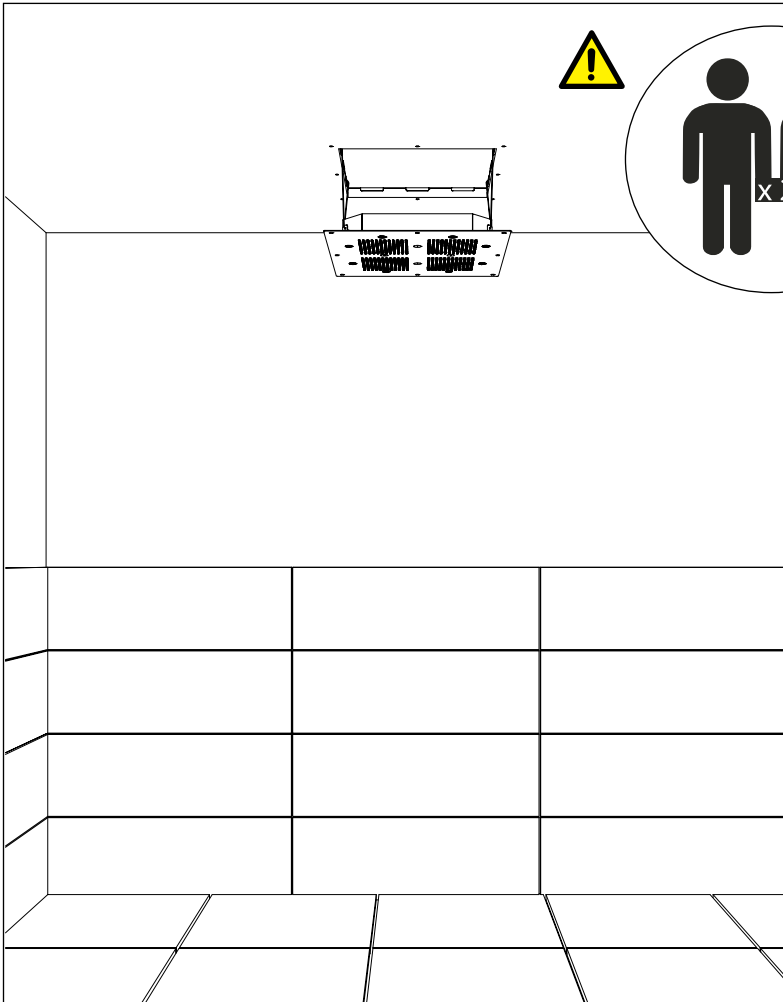

I



- Effettuare il collegamento idraulico/elettrico in base alla tipologia di soffione (Ved. pag. 8÷11)
- Make the connection to the hydraulic/electrical system according to the type showerhead. (see pag. 8÷11)

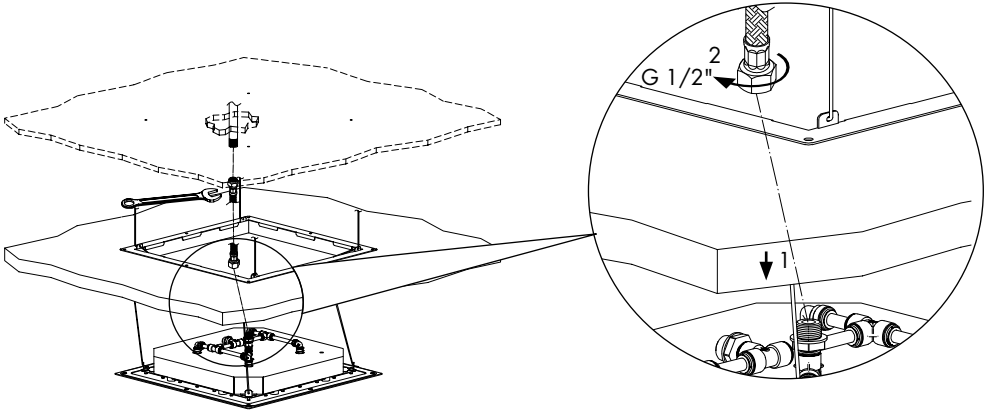

- Installare il tastierino, se previsto, seguendo le istruzioni da pag. 18, altrimenti proseguire dalla figura successiva "M"
- Install the keyboard, if applicable, following the instructions on page. 18, otherwise continue with the next figure "M"

m



- Fissare il soffione al controsoffitto e serrare le viti come indicato nella figura M, prestando particolare attenzione a non rovinare la finitura.
- Install the showerhead to the false ceiling and tighten the screw as shown in the figure M, be carefully, not scratch the surface.

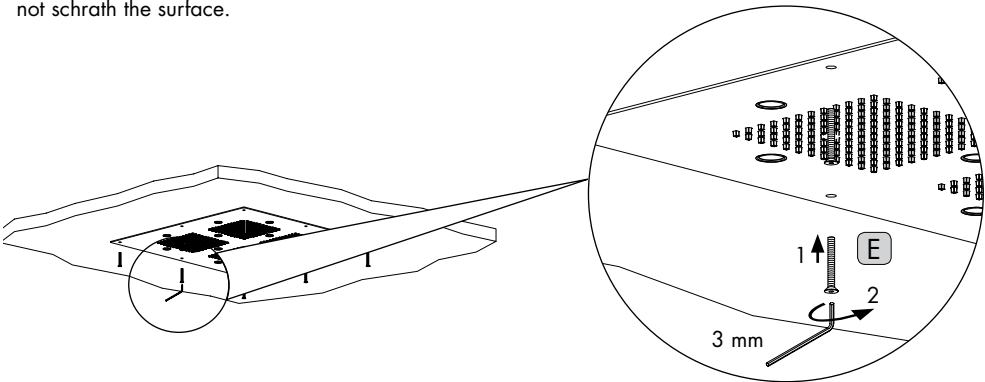

n

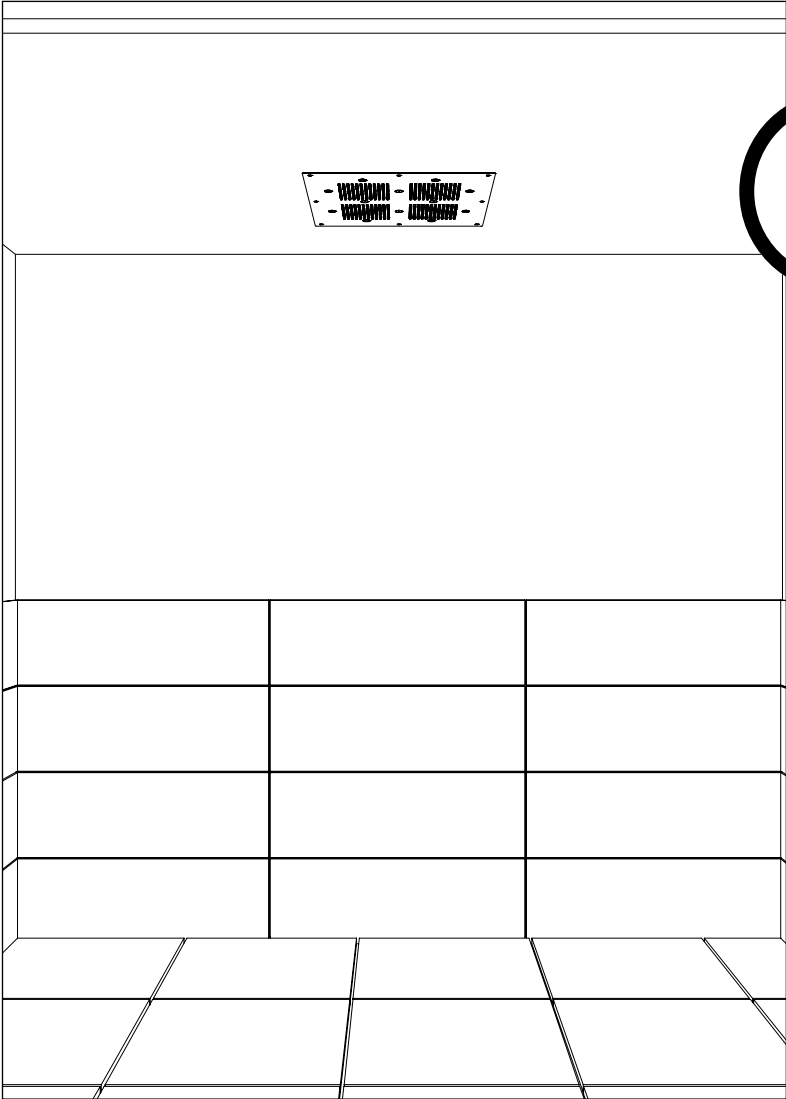

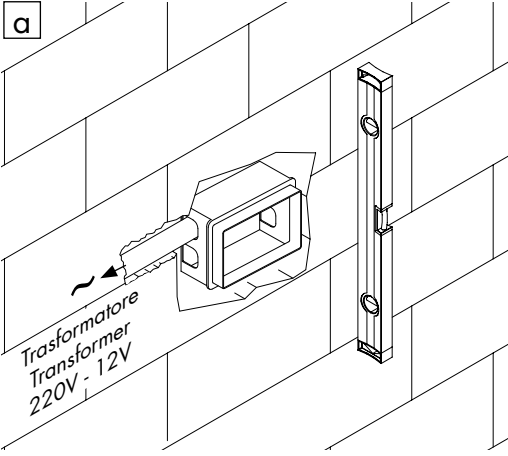

- Inserire nel muro la scatola di derivazione in dotazione e con l'ausilio di una livella posizionarla correttamente
- Insert the supplied junction box in the wall with the help of a level and position it properly

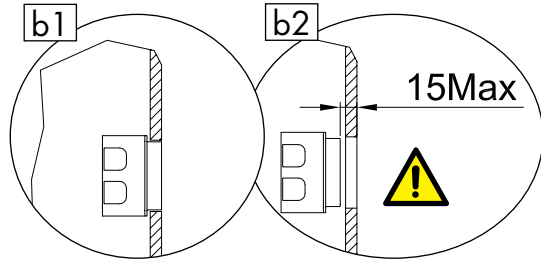
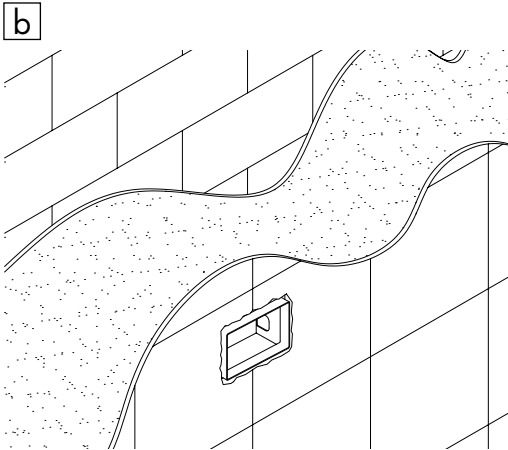

- Applicare il rivestimento e verificare che la scatola di derivazione sia a filo rivestimento (Fig. B1) o massimo 15 mm. (Fig. B2)
- Apply the plate and make sure the junction box is aligned with the plate (Fig. B1) or at a maximum of 15 mm. (Fig. B2)

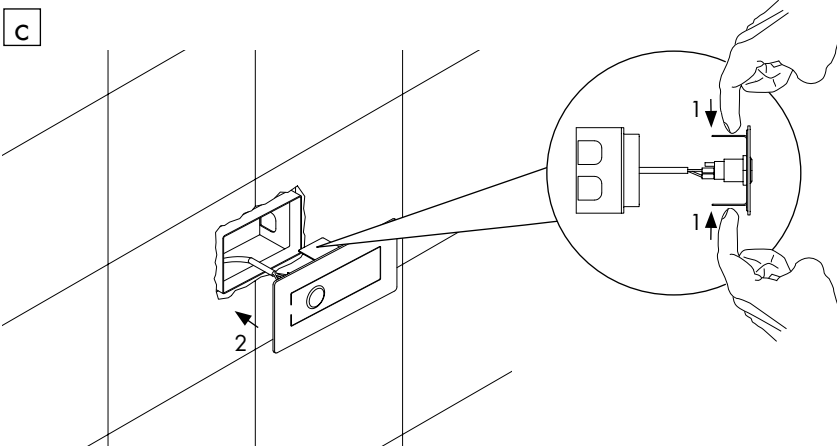

d

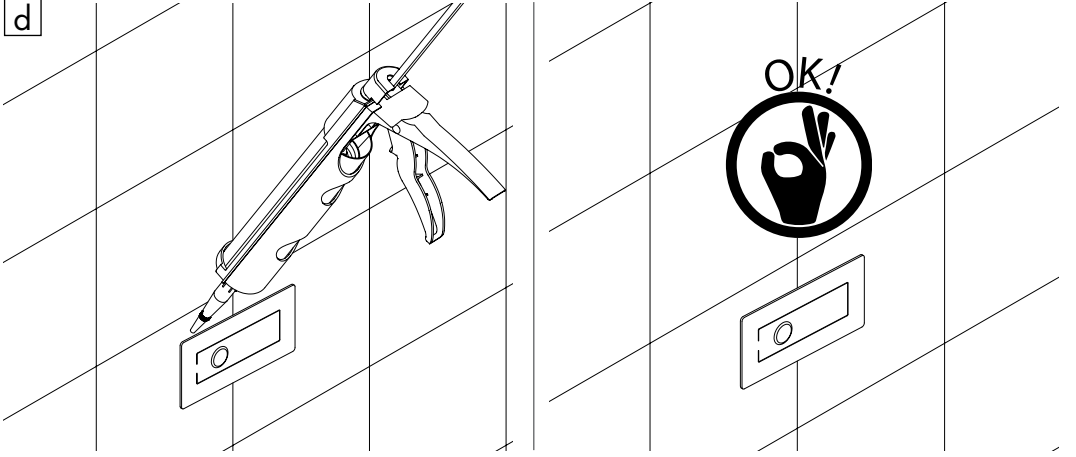

- Successivamente aver terminato l'installazione elettrica del tastierino all'interno del soffione, fissare quest'ultimo seguendo la sequenza "M" di pag. 16
- After finishing the installation of the electric keypad inside the shower head, fix the latter by following the sequence "M" on p. 16.

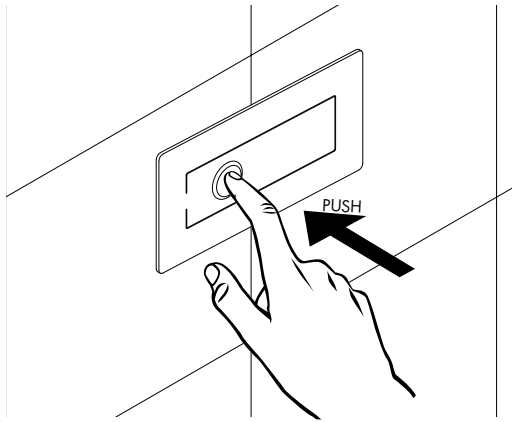

Push 	funzione	function
1	on luce colore verde	on colour green

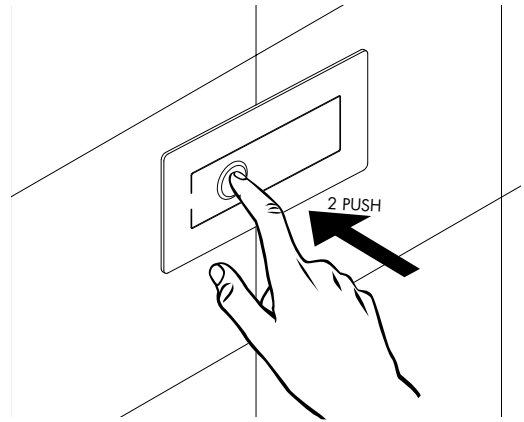

Push	funzione	function
1 + 1	colore azzurro	colour light blu
1 + 1	colore blu	colour blu
1 + 1	colore viola	colour violet
1 + 1	colore rosso	colour red
1 + 1	colore giallo	colour yellow
1 + 1	colore arancione	colour orange

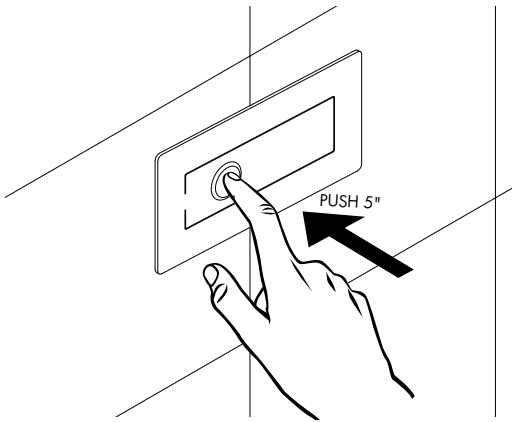

Push 	funzione	function
1 - 5"	loop automatico colori	automatic loop colors

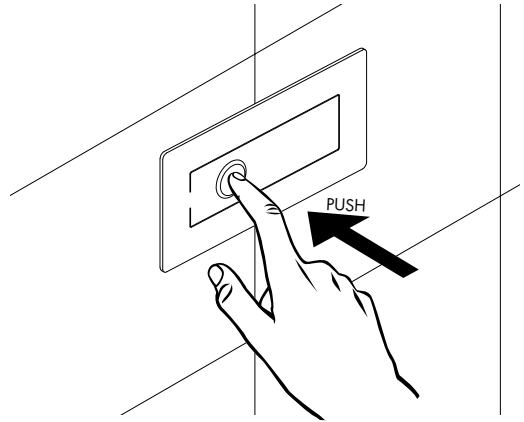

Push	funzione	function
1	spegnimento luci	OFF light

a

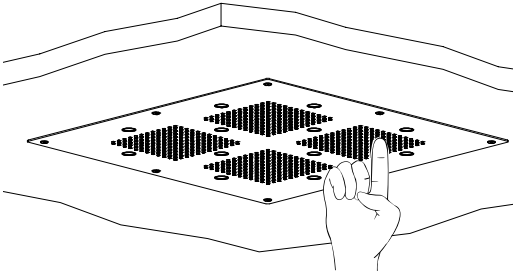

- Periodicamente pulire gli ugelli anticalcare come mostrato in figura "a"
- Periodically clean the nozzles to remove any lime scale as shown in Illustration "a"

Per preservare la qualità del prodotto si raccomanda di pulire le superfici in finitura esclusivamente con acqua e sapone neutro asciugandole con un panno morbido.

Non utilizzare detersivi o detersivi abrasivi o contenenti alcool, acidi, candeggina, cloro, solventi chimici, spugne abrasive, paglie metalliche, etc.

L'acqua contiene calcare in quantità variabili, il quale può depositarsi sulla superficie del prodotto formando macchie e depositi. E' possibile evitare la formazione di macchie di calcare pulendo ed asciugando il prodotto dopo ogni utilizzo.

Per evitare la formazione di calcare sugli ugelli strofinarli periodicamente con un panno umido.

In order to maintain the quality of products, surfaces must be cleaned exclusively using soapy water and dried with a soft cloth.

Never use detergents, powders or creams containing alcohol, acid, bleach, solvents, chemical agents, metal or abrasive sponges, etc.

Water contains limestone in variable quantity, which can remain on the surfaces leaving spots and forming deposits.

In order to avoid limestone deposits clean and dry the product immediately after use. It is possible to prevent limestone deposits on nozzles by regularly rubbing with a damp cloth.

CARATTERISTICHE TECNICHE

Tensione di alimentazione 12Vcc +/- 3%
Assorbimento massimo: 1.3 A – 8.4 A
Servizio di funzionamento: Continuo
Temperatura ambiente di funzionamento: da 0 a +40°C
Umidità relativa senza condensa: 5% a 90%
Grado di protezione: IP55
Connessioni d'ingresso e d'uscita: Morsetto a carrello
Norma di sicurezza: Non richiesta
Norma ENIC: EN55022/B



Prodotto LASER di Classe 2

Le radiazioni luminose di questa classe sono considerate a basso rischio, ma potenzialmente pericolose. Normalmente non producono danni permanenti se viste per pochi istanti da un occhio non protetto.

AVVERTENZE

Prima di collegare l'unità per la prima volta, leggere attentamente le sezioni seguenti. I voltaggi CA delle reti elettriche variano a seconda del paese.
Assicurarsi che il voltaggio presente nella vostra zona sia conforme con il voltaggio richiesto.



ALIMENTATORE

Tensione di alimentazione:
ingresso 190 -230 VAC 50/60Hz +/- 20%
uscita - 12Vcc +/- 3%
Potenza: 48 Watt

Si consiglia vivamente di utilizzare l'alimentatore fornito da Anpa; In caso di utilizzo di alimentatore diverso assicurarsi che le caratteristiche richieste siano compatibili con l'apparecchio. L'utilizzo di alimentatori con caratteristiche diverse o incompatibili possono danneggiare irreparabilmente il prodotto e far decadere la garanzia.

TECHNICAL FEATURES

Voltage supply: 12 Vcc +/- 3%
Maximum consumption: 1.3 A – 8.4 A
Functioning: Continuous
Ambient operating temperature: 0- +40 °
Relative non-condensing humidity: 5% -90%
Protection degree: IP55
Input and output connection: Rising clamp terminal block
Safety standard: Not required
Enic standard: EN55022/b



Class 2 LASER product

Class 2 light radiations are considered as posing a low risk, but potentially dangerous.

WARNING

Before connecting the unit for the first time, please read carefully the following sections.
AC voltages varies according to each country.
Ensure that the voltage of your local power supply corresponds to the required voltage.



FEEDER

Voltage supply:
Input 190 -230 VAC 50/60Hz +/- 20%
output - 12Vcc +/- 3%
Power: 48 Watt

It is strongly recommended to use the feeder provided by anpa. If a different feeder is to be used, please ensure that is compatible with the device.
The use of feeders with different characteristics or incompatible may damage the product and invalidate the warranty.

DICHIARAZIONE DI CONFORMITÀ



Noi,

ANPA srl

Viale dello Sport 16/18 - 21026 Gavirate (VA) Italy

Dichiariamo che il prodotto descritto in questo manuale è conforme alla Direttiva 2006/95/CE relativa al "Materiale elettrico destinato ad essere adoperato entro taluni limiti di tensione" e alla Direttiva 2004/108/CE relativa alla "Compatibilità Elettromagnetica"

DECLARATION OF CONFORMITY



We,

ANPA srl

Viale dello Sport 16/18 - 21026 Gavirate (VA) Italy

declare that the product featured in these instructions conforms to Directive 2006/95/CE relating to "Electrical equipment designed for use within certain voltage limits" and to Directive 2004/108/CE relating to "Electromagnetic compatibility".

Dati tecnici generali per l'impianto idraulico

Pressione minima di esercizio: 1,5 bar

Pressione di esercizio: campo di impiego ottimale consigliato
2,5 – 4 bar

Pressione massima di esercizio: 5 bar

(Per pressioni idrauliche superiori si consiglia l'utilizzo di un riduttore di pressione)

Temperatura massima di esercizio: 65 °C

I soffioni a parete sono dotati di limitatore di portata 12 lt/min.
(ove possibile).

Funzionamento minimo dei soffioni ad incasso:

Getto a pioggia: 16 lt/min. – 1,5 bar

Cascata singola: 10 lt/min. – 2 bar

Doppia cascata: 14 lt/min. – 2 bar

Funzionamento ottimale dei soffioni ad incasso:

Getto a pioggia: 18 lt/min. – 2,5 bar

Cascata singola: 14 lt/min. – 2,5 bar

Doppia cascata: 17 lt/min. – 2,5 bar



PROTEZIONE AMBIENTALE

I dispositivi elettrici ed elettronici non devono essere considerati rifiuti domestici. I consumatori sono obbligati dalla legge a restituire i dispositivi elettrici ed elettronici alla fine della loro vita utile ai punti di raccolta collettivi preposti per questo scopo o nei punti vendita.

Technical information for the hydraulic system

Minimum operating pressure: 1,5 bar

Operating Pressure: Optimal recommended use 2.5- 4 bar

Maximum operating pressure: 5 bar

(for higher hydraulic pressure it is recommended a pressure reducer)

Maximum operating temperature: 65 °C

Wall mount shower heads are equipped with a 12 l/m flow rate reducer (where possible).

Minimum supply required for false ceiling shower heads:

Rain function: 16 l/m – 1.5 bar

Cascade function: 10 l/m – 2 bar

Double cascade function: 14 l/m – 2 bar

Optimal supply for false ceiling shower heads:

Rain function: 18 l/m – 2.5 bar

Cascade function: 14 l/m – 2.5 bar

Double cascade function: 17 l/m – 2.5 bar



ENVIRONMENTAL PROTECTION

Electrical and electronic equipment is not to be treated as domestic refuse.

Consumers are obliged by law to dispose of no-longer useful electrical and electronic equipment at the appropriate collection or sales points.

