



BAGNO  
ITALIANO



**FREESTANDING ACRYLIC BATHTUBS / PRICELIST 2016**

## CONTENT

### FREESTANDING BATHTUBS

Modern Designs | 04 – 09  
Concept Designs | 10 – 13  
Traditional Designs | 14-17  
Special Designs | 18-21

### BUILT-IN BATHTUBS

Classic Designs | 22 – 25

### OPTIONS & ACCESSOIRE

Waste & Feet Options | 26 – 27  
Color Options & Features | 28 – 29

### WELLNESS DESIGNS

Freestanding Wellness Options | 30 – 33  
Built-In Wellness Options | 34 – 37

### SHOWER TRAYS | 38 – 41

### GENERAL TERMS & CONDITIONS | 42 – 43

### CONTACT | 44

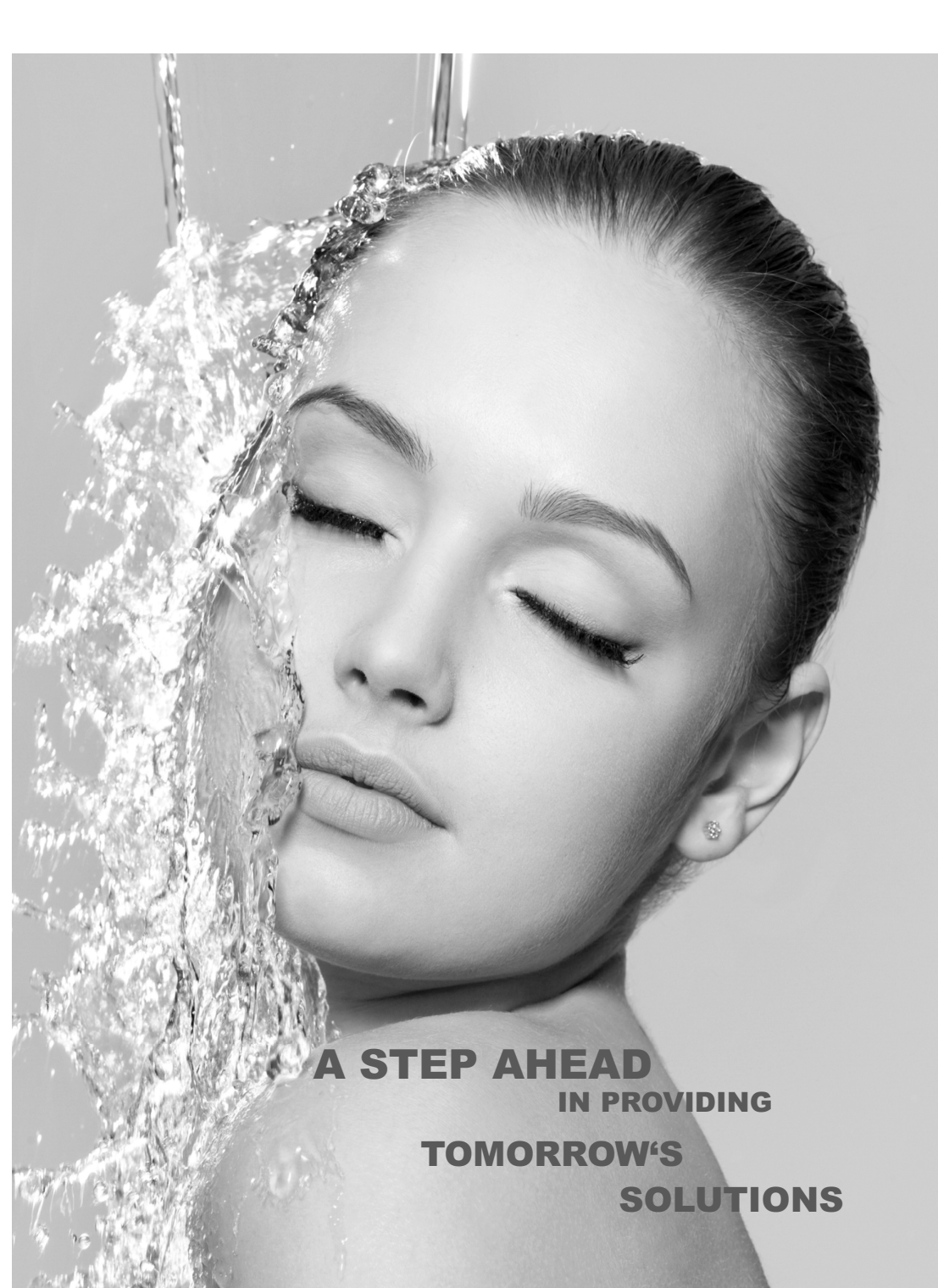
A black and white photograph of a woman's face and shoulders in a shower. Water is spraying over her head and shoulders. She has her eyes closed and a serene expression. Her hair is pulled back. She is wearing a small stud earring.

**A STEP AHEAD  
IN PROVIDING  
TOMORROW'S  
SOLUTIONS**

# MODERN DESIGNS











## PERFECTLY DESIGNED IN SHAPE AND QUALITY

Bathrooms are increasingly becoming an important living space with modern character, combining individual design demands with the ambience of meditative peace or stimulating vitality. We make your dreams come true! Experience our vast range of modern freestanding bathtubs and enjoy the luxury and fascination of our unique designs in incomparable manner!

	Dimensions (l x w x h)	Article number	
	CLUB	Ø 1600x620 mm	0100-075
	COOL	1800x800x600 mm	0100-082
	COSY	1800x850x600 mm	0100-297
	CUBE	1700x800x600 mm	0100-284
	CUBE XS	1550x800x600 mm	0100-254
	CULTURE	1800x800x600 mm	0100-068
	FORM	1900x900x600 mm	0100-087
	FORM XS	1550x750x600 mm	0100-257
	HOT	1800x800x600 mm	0100-077
	LOFT	1800x800x600 mm	0100-067
	LOFT IV	1800x850x700 mm	0100-067-06
<b>Bath Waste Kits</b>			
Kit A	col. chrome	0100-091-06	
Kit A	col. chrome with integrated bath filler via overflow	0100-091-07	
Kit A	col. chrome with integrated bath filler via waste	0100-091-13	
Kit B	col. chrome	0100-091-04	
Kit B	col. brass	0100-091-03	
Kit B	col. aluminum brushed	0100-091-05	

Color	Specification	Bath waste kit option	Price*
white / white	incl. special floorfix system	bath waste kit A	3.085,00 EUR
white / white	incl. special floorfix system	bath waste kit A	1.545,00 EUR
white / white	incl. special floorfix system	bath waste kit A	2.265,00 EUR
white / white	incl. special floorfix system	bath waste kit A	2.055,00 EUR
white / white	incl. special floorfix system	bath waste kit A	1.745,00 EUR
white / white	incl. special floorfix system	bath waste kit A	2.055,00 EUR
white / white	incl. special floorfix system	bath waste kit A	2.055,00 EUR
white / white	incl. special floorfix system	bath waste kit A	1.745,00 EUR
white / white	incl. special floorfix system	bath waste kit A	1.645,00 EUR
white / white	incl. special floorfix system	bath waste kit A	1.545,00 EUR
white / white	incl. special floorfix system	bath waste kit A	1.995,00 EUR
Click-Clack-system, with p-trap and flexible hose, factory fitted to the bath			95,00 EUR
Click-Clack-system, with p-trap and flexible hose, factory fitted to the bath			305,00 EUR
Click-Clack-system, with brass p-trap and hose, factory fitted to the bath			755,00 EUR
Click-Clack-system, with brass p-trap and hose, factory fitted to the bath			305,00 EUR
Click-Clack-system, with brass p-trap and hose, factory fitted to the bath			305,00 EUR
Click-Clack-system, with brass p-trap and hose, factory fitted to the bath			305,00 EUR

		Dimensions (l x w x h)	Article number
	LOOM	1900x950x600 mm	0100-088
	LOOM XS	1700x850x600 mm	0100-058
	LOUNGE	1850x950x635 mm	0100-089
	MOOD	1800x800x600 mm	0100-085
	NEO	1700x800x600 mm	0100-076
	OVAL	1800x950x600 mm	0100-080
	RELAX	1800x850x620/760 mm	0100-278
	VENICE	1800x835x745 mm	0100-083

**Bath Waste Kits**

Kit A	col. chrome	0100-091-06
Kit A	col. chrome with integrated bath filler via overflow	0100-091-07
Kit A	col. chrome with integrated bath filler via waste	0100-091-13
Kit B	col. chrome	0100-091-04
Kit B	col. brass	0100-091-03
Kit B	col. aluminum brushed	0100-091-05

Color	Specification	Bath waste kit option	Price*
white / white	incl. special floorfix system	bath waste kit A	2.265,00 EUR
white / white	incl. special floorfix system	bath waste kit A	2.055,00 EUR
white / white	incl. special floorfix system	bath waste kit A	2.055,00 EUR
white / white	incl. special floorfix system	bath waste kit A	2.055,00 EUR
white / white	incl. special floorfix system	bath waste kit A	1.745,00 EUR
white / white	incl. special floorfix system	bath waste kit A	2.055,00 EUR
white / white	incl. special floorfix system	bath waste kit A	2.365,00 EUR
white / white	incl. special floorfix system	bath waste kit A	2.055,00 EUR

Click-Clack-system, with p-trap and flexible hose, factory fitted to the bath	95,00 EUR
Click-Clack-system, with p-trap and flexible hose, factory fitted to the bath	305,00 EUR
Click-Clack-system, with brass p-trap and hose, factory fitted to the bath	755,00 EUR
Click-Clack-system, with brass p-trap and hose, factory fitted to the bath	305,00 EUR
Click-Clack-system, with brass p-trap and hose, factory fitted to the bath	305,00 EUR
Click-Clack-system, with brass p-trap and hose, factory fitted to the bath	305,00 EUR











# CONCEPT DESIGNS



## SECOND TO NONE EVOLUTION IN DESIGN

Multiplication! A successful concept developed in an intelligent way. Our new concept series are developed from and centered around the design of the freestanding model. The wall-flush concepts suit very well for the commercial renovation sector.

All designs are unique and offer intelligent solutions especially for small rooms! The full body design makes tiling dispensable and installation very easy.

	Dimensions (l x w x h)	Article number
<b>WALL CONCEPT</b>		
 HOT	1800x800x600 mm	0100-272
 WALL	1800x800x600 mm	0100-277
 WALL CORNER LEFT	1800x800x600 mm	0100-277-L
 WALL CORNER RIGHT	1800x800x600 mm	0100-277-R
<b>DREAM CONCEPT</b>		
 DREAM	1800x800x600 mm	0100-082
 DREAM WALL	1800x800x600 mm	0100-082
<b>FRESH CONCEPT</b>		
 FRESH	1800x800x600 mm	0100-230
 FRESH WALL	1800x800x600 mm	0100-231
 FRESH LEFT	1800x800x600 mm	0100-232
 FRESH RIGHT	1800x800x600 mm	0100-233
<b>Bath Waste Kits</b>		
Kit A	col. chrome	0100-091-06
Kit A	col. chrome with integrated bath filler via overflow	0100-091-07
Kit A	col. chrome with integrated bath filler via waste	0100-091-13

Color	Specification	Bath waste kit option	Price*
white / white	incl. special floorfix system	bath waste kit A	1.645,00 EUR
white / white	incl. special wallfix system	bath waste kit A	1.435,00 EUR
white / white	incl. special wallfix system	bath waste kit A	1.435,00 EUR
white / white	incl. special wallfix system	bath waste kit A	1.435,00 EUR
white / white	incl. special wallfix system	bath waste kit A	2.055,00 EUR
white / white	incl. special wallfix system	bath waste kit A	2.145,00 EUR
white / white	incl. special floorfix system	bath waste kit A	1.645,00 EUR
white / white	incl. special wallfix system	bath waste kit A	1.645,00 EUR
white / white	incl. special wallfix system	bath waste kit A	1.645,00 EUR
white / white	incl. special wallfix system	bath waste kit A	1.645,00 EUR
Click-Clack-system, with p-trap and flexible hose, factory fitted to the bath			95,00 EUR
Click-Clack-system, with p-trap and flexible hose, factory fitted to the bath			305,00 EUR
Click-Clack-system, with brass p-trap and hose, factory fitted to the bath			755,00 EUR

# TRADITIONAL DESIGNS



## PERFECT BATHING CULTURE INSPIRES YOUR SENSES

Imbue your bath with your personality and give it an individual character. Use your imagination and feel the inspiration of ancient centuries. We take you on a journey of mind picking up international styles and influences and transferring them into the luxury design of our bathtubs.

Select from a huge variety of our traditional design freestanding bathtubs and make your bath a little more beautiful.



		Dimensions (l x w x h)	Article number
	CHATEAU	1800x800x600 mm	0100-073-01 0100-073-02
	EDWARDIAN	1700x750x600 mm	0100-062-01 0100-062-02
	EDWARDIAN XL	1800x800x600 mm	0100-063-01 0100-063-02
	PRINCESS	1700x700x660 mm	0100-081
	PRINCESS I	1700x700x660 mm	0100-081-01
	RETRO	1800x850x630 mm	0100-090
	ROLL TOP	1525x720x550 mm	0100-065-01 0100-065-02
	ROLL TOP XL	1700x700x600 mm	0100-066-01 0100-066-02
	SLIPPER	1515x725x785/570 mm	0100-064-01 0100-064-02
	VICTORIAN	1745x830x810/7650 mm	0100-061-01 0100-061-02

**Bath Waste Kits**

Kit B	col. chrome	0100-091-04
Kit B	col. brass	0100-091-03
Kit B	col. aluminum brushed	0100-091-05
Kit C	col. brass	0100-091-01
Kit C	col. Chrome	0100-091-02

Color	Specification	Bath waste kit option	Price*
white / white	With 4 claw feet, pol brass With 4 claw feet, chrome	bath waste kit C	2.055,00 EUR
white / white	With 4 claw feet, pol brass With 4 claw feet, chrome	bath waste kit C	1.645,00 EUR
white / white	With 4 claw feet, pol brass With 4 claw feet, chrome	bath waste kit C	1.745,00 EUR
white / white	incl. special floorfix system	bath waste kit B	1.645,00 EUR
white / white	With acrylic plinth, col. white	bath waste kit B	2.055,00 EUR
white / white	With acrylic plinth, col. white	bath waste kit A	2.365,00 EUR
white / white	With 4 claw feet, pol brass With 4 claw feet, chrome	bath waste kit C	1.545,00 EUR
white / white	With 4 claw feet, pol brass With 4 claw feet, chrome	bath waste kit C	1.645,00 EUR
white / white	With 4 claw feet, pol brass With 4 claw feet, chrome	bath waste kit C	1.645,00 EUR
white / white	With 4 lion feet, pol brass With 4 lion feet, chrome	bath waste kit C	1.745,00 EUR











Click-Clack-system, with brass p-trap and hose, factory fitted to the bath	305,00 EUR
Click-Clack-system, with brass p-trap and hose, factory fitted to the bath	305,00 EUR
Click-Clack-system, with brass p-trap and hose, factory fitted to the bath	305,00 EUR
Plug & chain, with brass p-trap and hose, factory fitted to the bath	245,00 EUR
Plug & chain, with brass p-trap and hose, factory fitted to the bath	245,00 EUR

## ELABORATE DESIGN IDEAS SATISFY AESTHETIC CREATIVITY DEMANDS

Creative work and the choice of individual accessories and options are the icing on the cake. They make your bathroom inevitably special!

Our Special Design models show in perfection the diversity of outstanding combinations of different materials. All parts are of highest quality and individually handcraft made. That makes every bathtub singular! Enjoy the luxury and fascination of our unique special design bathtubs and refine your everyday life.



	Dimensions (l x w x h)	Article number	
	EDWARDIAN I	1700x750x600 mm	0100-062-06
	EDWARDIAN II	1700x750x600 mm	0100-062-08
	LOFT I	1850x835x600 mm	0100-067-01 0100-067-02
	LOFT II	1800x800x650 mm	0100-067-03
	LOFT III	1850x835x650 mm	0100-067-04 0100-067-05
	LOFT V	1850x835x690 mm	0100-067-07 0100-067-08
	LOOK	1800x800x600 mm	0100-250
	PRINCE	1700x700x685 mm	0100-086
	VICTORIAN I	1745x830x820/650 mm	0100-061-06
	WALL XS	1650x750x580 mm	0100-255

**Bath Waste Kits**

Kit A	col. chrome	0100-091-06
Kit A	col. chrome with integrated bath filler via overflow	0100-091-07
Kit A	col. chrome with integrated bath filler via waste	0100-091-13
Kit B	col. chrome	0100-091-04
Kit B	col. brass	0100-091-03
Kit B	col. aluminum brushed	0100-091-05
Kit C	col. brass	0100-091-01
Kit C	col. chrome	0100-091-02

Color	Specification	Bath waste kit option	Price*
white / white	With teak console, natural colored	bath waste kit C	2.365,00 EUR
white / white	With 2 teak consoles, natural colored	bath waste kit C	2.055,00 EUR
white / white	With rail, chrome With rail, polished brass	bath waste kit B	2.265,00 EUR
white / white	With 2 teak consoles, natural colored	bath waste kit B	2.055,00 EUR
white / white	With 2 teak consoles & rail, chrome	bath waste kit B	2.755,00 EUR
white / white	With 2 teak consoles & rail, polished brass	bath waste kit B	
white / white	With white acrylic plinth & rail, chrome	bath waste kit B	2.675,00 EUR
white / white	With white acrylic plinth & rail, polished brass	bath waste kit B	
white / white	incl. tray, color white	bath waste kit A	3.085,00 EUR
white / white	with aluminum outer, brushed	bath waste kit B	3.085,00 EUR
white / white	With teak console, natural colored	bath waste kit C	3.085,00 EUR
white / white	incl. special wallfix system	bath waste kit A	1.595,00 EUR

Click-Clack-system, with p-trap and flexible hose, factory fitted to the bath	95,00 EUR
Click-Clack-system, with p-trap and flexible hose, factory fitted to the bath	305,00 EUR
Click-Clack-system, with p-trap and flexible hose, factory fitted to the bath	755,00 EUR
Click-Clack-system, with brass p-trap and hose, factory fitted to the bath	305,00 EUR
Click-Clack-system, with brass p-trap and hose, factory fitted to the bath	305,00 EUR
Click-Clack-system, with brass p-trap and hose, factory fitted to the bath	305,00 EUR
Plug & chain, with brass p-trap and hose, factory fitted to the bath	245,00 EUR
Plug & chain, with brass p-trap and hose, factory fitted to the bath	245,00 EUR





# CLASSIC DESIGNS



## BEAUTIFUL SHAPES IN CREATIVE CLASSIC DESIGN CAPTURE YOU ON A JOURNEY OF MIND

Create a symbiosis of materials and get your individual style to your bathroom. The combination of unique Aqua Plus® Classic design bathtubs and elegant tiles or wooden furniture will create a worldwide single design in your bathroom.

All Classic models are based on the construction of our freestanding designs. If you prefer built-in bathtubs – select from the variety of our Aqua Plus® Classic designs!

		Dimensions (l x w x h)	Article number
	COOL FIT	1800x800x600 mm	0400-282
	CULTURE FIT	1800x800x600 mm	0400-268
	FORM FIT	1900x900x600 mm	0400-287
	LOOM FIT	1900x950x600 mm	0400-288
	LOUNGE FIT	1850x950x635 mm	0400-289
	MOOD FIT	1800x800x600 mm	0400-285
	RELAX FIT	1800x850x620/765 mm	0400-278
	VENICE FIT	1800x835x745 mm	0400-283

**Bath Waste Kits**

Kit A	col. chrome	0100-091-06
Kit A	col. chrome with integrated bath filler via overflow	0100-091-07
Kit A	col. chrome with integrated bath filler via waste	0100-091-13

Color	Specification	Bath waste kit option	Price*
white / white	incl. slot overflow, special Aqua-maxx reinforcement and metal frame with adjustable legs	bath waste kit A	745,00 EUR
white / white	incl. slot overflow, special Aqua-maxx reinforcement and metal frame with adjustable legs	bath waste kit A	745,00 EUR
white / white	incl. slot overflow, special Aqua-maxx reinforcement and metal frame with adjustable legs	bath waste kit A	865,00 EUR
white / white	incl. slot overflow, special Aqua-maxx reinforcement and metal frame with adjustable legs	bath waste kit A	865,00 EUR
white / white	incl. slot overflow, special Aqua-maxx reinforcement and metal frame with adjustable legs	bath waste kit A	945,00 EUR
white / white	incl. slot overflow, special Aqua-maxx reinforcement and metal frame with adjustable legs	bath waste kit A	745,00 EUR
white / white	incl. slot overflow, special Aqua-maxx reinforcement and metal frame with adjustable legs	bath waste kit A	945,00 EUR
white / white	incl. slot overflow, special Aqua-maxx reinforcement and metal frame with adjustable legs	bath waste kit A	945,00 EUR

Click-Clack-system, with p-trap and flexible hose, factory fitted to the bath	95,00 EUR
Click-Clack-system, with p-trap and flexible hose, factory fitted to the bath	305,00 EUR
Click-Clack-system, with brass p-trap and hose, factory fitted to the bath	755,00 EUR

MODERN BATH WASTE KITS



ROUND overflow

Round overflow with click-clack waste with p-trap and flexible hose, standard colour chrome, factory fitted. Available colors upon request: satinated inox, white, gold Available for all modern design baths

Price\*: 95,00 EUR



ROUND overflow with integrated filler

Round overflow with click-clack waste with p-trap and flexible hose, standard colour chrome, factory fitted. Available colors upon request: satinated inox, white Available for all modern design baths

Price\*: 305,00 EUR



ROUND overflow with integrated waste filler

Rotating overflow with integrated waste filler, with p-trap and flexible hose, standard colour chrome, factory fitted. Available colors upon request. Available for all modern design baths

Price\*: 755,00 EUR

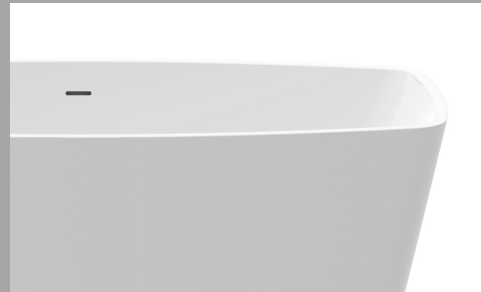

SLOT overflow

Slot overflow with click-clack waste with p-trap and flexible hose, standard colour chrome, factory fitted. Waste colors upon request: satinated inox, white, gold Available for all modern & FIT design baths

Price\*: 95,00 EUR

TRADITIONAL BATH WASTE KITS



Plug & Chain, with brass p-trap

with brass L- waste pipe, standard colours chrome, polished brass, factory fitted. Available colors upon request: bronze

Available for all Edwardian, Victorian, Roll Top, Cahteau and Slipper designs.

Color polished brass – art. no. 0100-091-01  
Color chrome – art. no. 0100-091-02

Price\*: 245,00 EUR



Click-Clack system, with brass p-trap

with brass L-waste pipe, standard colours chrome, polished brass, aluminum brushed factory fitted.

Available for all Prince, Princess and Loft designs.

Color polished brass – art. no. 0100-091-03  
Color chrome – art. no. 0100-091-04  
Color aluminum brushed – art. no. 0100-091-05

Price\*: 305,00 EUR

FEET



Lion feet (for Victorian bath) inclusive

Polished brass: art.-no. 0100-061-01  
Chrome: art.-no. 0100-061-02



Claw feet inclusive

Polished brass: art.-no. 0100-061-01  
Chrome: art.-no. 0100-061-02

COLOR OPTIONS



BI - COLOR

All freestanding models are available in bi-color in following glossy colors:  
 Black  
 Racing green  
 Bordeaux red  
 Rooyal blue

Price: + 20% (surcharge on bathtub price)



All freestanding models are available in bi-color  
 With leaf gold or silver  
 With black or white ground

Price: + 30% (surcharge on bathtub price)



UNI-COLOR

All freestanding models are available fully colored in following glossy colors:  
 Black  
 Racing green  
 Bordeaux red  
 Rooyal blue  
 White mat

Price: + 30% (surcharge on bathtub price)

FIXING OPTIONS

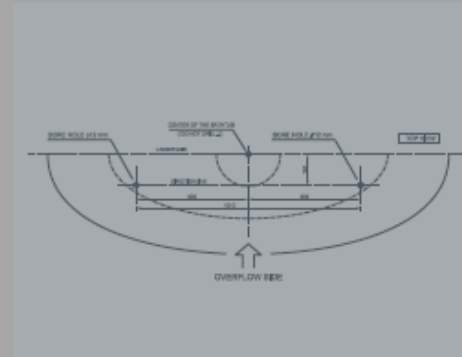

Floorfix & Mounting included

Floorfix and Wallfix – the unique concept of floor or wall fixation for freestanding and wall fixed bathtubs!  
 This set consists of appropriate fixation material (screws, & pins) to guarantee firm standing on the floor. Each bathtub is delivered with comprehensive floor drilling template and pictogram-mounting-instruction.

Available for all modern and some special designs (see specification)

INVISIBLE JOINTING

INVISIBLE JOINTING



VISIBLE JOINTING

- Knief & Co. engineered this outstanding technique in an own, fully independent developed project
- As the only manufacturer in the market Knief & Co. offers bathtubs with invisible jointing
- NO gel coating or paint is ever used to cover the line between outer and inner shell
- **Result: NO visible jointing** between inner and outer shell  
 => **FULL BODY MATERIAL which is repairable**
- Currently available for modern designs: Cosy, Cube, Cube XS, Form, Form XS, Hot, Loom, Loom XS, Lounge, Neo, Relax, Wall, Wall Corner L+R, Fresh Concept, Dream Concept

included

# WELLNESS DESIGNS FREESTANDING MODELLS



## SURRENDER TO THE UNIQUE BATHING EXPERIENCE OF AQUA SPA®

Our Aqua Spa® wellness system is capable of being integrated into many of our Aqua Plus® bathtub models. All electronic parts fulfill the demands of IPX5 protection rating standard. Knief & Co.'s Aqua Spa® collection is manufactured exclusively in Europe, fulfilling highest quality requirements. We grant a 2 years warranty on all wellness system components. Aqua Spa® bathtubs are made of best Lucite® sanitary cast acrylic (compliant with EN 263) fulfilling highest quality standards due to CE conformity EN 14516 – same as Aqua Plus® bathtubs do. Aqua Spa® bathtubs are in compliance to DIN 4109 and SIA 181.



**FOR FREESTANDING BATHTUBS**

**1. WELLNESS PURE**

- 24 ultra-flat air nozzles
- Ozone therapy
- Automatic drying system
- Remote control



Price\*

EUR 3.450,00

**2. WELLNESS PREMIUM**

- 24 ultra-flat air nozzles
- Ozone therapy
- Automatic drying system
- 20 mini LED light chain or 2 power LED
- Remote control



Price\*

EUR 4.950,00

**3. WELLNESS DELUXE**

- 24 ultra-flat air nozzles
- 20 mini LED light chain or 2 power LED
- Sound system with 2 loudspeakers,
- Radio and WLAN connection
- to MP3 player
- Ozone therapy
- Automatic drying system
- Remote control



Price\*

EUR 7.950,00

**LIGHT**

It is said that colour has an impact on the human body and soul and can optimize your energy level. Aqua Spa® wellness bathtubs equipped with ambience light will increase your bathing enjoyment and convert your bathroom into an atmospheric space. Choose between our 20 mini LED light-chain and 2 power LED. 10 changing colour modes of white, purple, blue, light blue, turquoise, green, yellow, orange, red and pink will enhance your senses to a maximum experience of luxury relaxing comfort. Blue is your favorite? No problem! With our integrated remote control you may stop the changing colours at your favored colour or switch on and off the light function. The light intensity of the power LEDs is even dimmable!

**SOUND**

“Without music, life would be an error“ (Friedrich Nietzsche). Enjoy your own MP3 music composition or your favorite radio station using the integrated sound system. The set also consists of 2 integrated not visible loudspeakers which give you a perfect sound experience. You can choose your own program via remote control and having your MP3 player connected via WLAN.

**WHISPER AIR NOZZLES**

Listen to the silence! With the calmness of our Aqua Spa® system the only recognizable noise is the whisper of soft sparkling water. Lay down and relax, enjoying a pearling massage while reading a book without disturbing noise and extruding water. 24 ultra-flat and ergonomically adjusted whisper air jets grant you a maximum bathing comfort.

**OZONE Therapy**

Switch on the integrated Ozone blower! Like this the air escaping from the nozzles is mixed with Ozone. With this function the quality of your bathwater is enhanced due the antibacterial and disinfecting effect of Ozone. Moreover the skin is enriched with oxygen and the blood circulation is stimulated. This option is automatically activated starting the system. Via remote control this option can be switched off and on.

**AUTOMATIC DRYING SYSTEM**

To dry the air nozzles from remnant water and to avoid bacteria and off odors our Aqua Spa® wellness bathtubs are equipped with an automatic drying system. 15 minutes after emptying the tub this function switches on automatically and runs for 2 minutes. This ensures you a unproblematic, long lasting pleasure in using your Aqua Spa® bathtub. The drying system may be also started manually by remote control.

**DESINFECTION**

Easy to care! Due to our automatic drying system no additional disinfection of the nozzles is necessary. Eventually into the nozzles entering water is blown out completely. So “cleaning” is taken care of itself.

**PROTECTION AGAINST DRY RUNNING**

Our Aqua Spa® wellness bathtubs are equipped with a dry running system to prevent the air system running without water.

**REMOTE CONTROL**

Keeping it simple! Our Aqua Spa® wellness bathtubs are easy to serve. All features are operable with one control. By its intuitive menu all options are easy to identify. To make it perfect the modern design of the remote control fits well to the pure appearance of our Aqua Spa® bathtubs. Surrender to the unique bathing experience of Aqua Spa®!

*Create your individual Spa! We fulfil your desires and configure your Spa according to your special needs and ideas (if technically applicable to the model).*

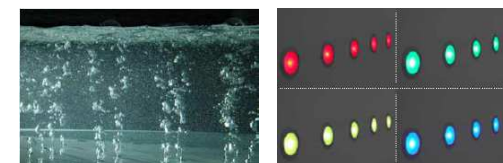

*\*Price for the required bathtub to be added accordingly*

# WELLNESS DESIGNS BUILT-IN MODELLS



## SURRENDER TO THE UNIQUE BATHING EXPERIENCE OF AQUA SPA®

Our Aqua Spa® wellness system is capable of being integrated into many of our Aqua Plus® bathtub models. All electronic parts fulfill the demands of IPX5 protection rating standard. Knief & Co.'s Aqua Spa® collection is manufactured exclusively in Europe, fulfilling highest quality requirements. We grant a 2 years warranty on all wellness system components. Aqua Spa® bathtubs are made of best Lucite® sanitary cast acrylic (compliant with EN 263) fulfilling highest quality standards due to CE conformity EN 14516 – same as Aqua Plus® bathtubs do. Aqua Spa® bathtubs are in compliance to DIN 4109 and SIA 181.

**FOR BUILT-IN BATHTUBS**

**1. Economic**

- 6 hydro nozzles
- 0,55 kW pump
- air dosage regulator
- water level sensor
- electronic control panel
- waste/overflow system



Price\*

**EUR 995,00**

**2. De Luxe**

- 6 hydro nozzles
- 2 nozzles in the feet level
- 0,81 kW pump
- air dosage regulator
- water level sensor
- electronic control panel
- waste/overflow system



Price\*

**EUR 1.495,00**

**3. De Luxe Plus**

- 6 hydro nozzles
- 2 nozzles in the feet level
- 4 micro nozzles in the backside of the body level
- rotary nozzle for the lumbar massage
- 0,81 kW pump
- air dosage regulator
- water level sensor
- electronic control panel
- waste/overflow system



Price\*

**EUR 1.595,00**

**4. Premium Plus**

- 6 hydro nozzles
- 2 nozzles in the feet level
- 4 micro nozzles in the backside of the body level
- rotary nozzle for the lumbar massage
- 12 air nozzles
- 0,75 kW pump
- 7 kW compressor
- electronic control panel
- valve to protect the compressor from the watering
- wave effect
- waste/overflow system
- water reflector
- disinfection system
- auto-cleaning capability



Price\*

**EUR 2.395,00**

**ECONOMIC**

The main principle of the Economic hydro massage is the turbulence, and the water flow it creates and effectively massages your body in the bath tub. The water is being injected under pressure through 6 mini hydro nozzles located on the lateral bath tub walls. The electro pump reuses the water in the bath tub, and created the pressure in the process. The massage effect can be adjusted by injecting some air into the water through the nozzles. This adjustment works on the principles of the "Venturi effect", the reduction of fluid pressure when a fluid flows through a constricted section of a pipe. Simplicity and reliability are the main features of the Economic massage system, and it is a perfect fit for smaller bathtubs.

**DELUXE**

In its standard equipment, De Luxe hydro massage is equipped with 8 hydro nozzles. Each of these nozzles can be individually opened, closed and directed to suit your individual preferences the best. All of the nozzles are carefully positioned in the way to enable the massage effect to be maximized on every part of your body. De Luxe massage system is suitable for all regular and corner bathtubs. It can be upgraded to De Luxe plus massage system.

**DELUXE PLUS**

De Luxe plus massage system contains the same equipment as DeLuxe massage system, with the addition of 4 micro nozzles in the backside of the body level and one rotary nozzle intended for the lumbar massage.

**PREMIUM PLUS**

The world we live in has dramatically changed in the last few decades. The rhythm of life is much faster than before; most people live under constant pressure to be successful in the workplace and at home. Consequently, people don't have time for themselves as they used to have before. This lifestyle is taking a toll both on your body and soul.

How many times did you come home, and wanted a moment just for yourself, to relax and recharge your batteries for the challenges that are yet to come? The perfect solution would be to go to the nature and do some sports and outdoor activity, but unfortunately you don't always have time or place to do that.

The good news is that you can have a perfect combination of all of that in your home with our valued Wellness solutions enabling you to recharge your energy making you fit for today's challenges. Not only that you will influence your mental health by using the massage systems, but your physical health will benefit significantly as well. It is proven that using a massage bath tub will help with: blood circulation and will help with leg swelling problems; is a powerful ally in a fight with cellulite (an eternal female complaint, and a growing problem) – the combination with chromo therapy is particularly effective; helps the organism to release the harmful toxins from the body; lessens the joint pains. Sportspersons will particularly value the ability of massage systems to relax the body after an exercise; support and strengthen up the inner muscle fiber layers and tissues; provide a support in healing of the sports injuries.

If combined with chromo therapy and aroma therapy, the massage system will be the most effective for your body, and will provide you with an unmatched experience right in the commodity of your home!

*\*Price for the required bathtub to be added accordingly*

# SHOWER TRAYS



## AQUA TECC® SHOWER TRAYS ULTRA FLAT & FLUSH TO FLOOR

Since the beginning of modern time mankind has been purged by flowing water over their head. Modern bathrooms become a living space with individual character, combining useful everyday life components with homelike interior design. Nowadays life is unthinkable without a shower. Wake up and enjoy a refreshing douche in the morning or wash away your sorrows and relax in the evening.

As individual you are, as individual are the dimensions and options of our ultra-flat shower trays. With our modern Aqua Tecc® technology we offer a variety of 18 aesthetic sizes for the flush-to-floor shower area setting new standards in size and versatility. Additionally we give our clients the choice of creating individual dimensions to fulfill their design dreams.

All sizes fulfill every aesthetical demand, are fascinatingly flat and easy to enter, bringing luxury and comfort to your bathroom. Starting with well-known sizes of 800 x 800 mm we also offer extra-large dimensions up to 1800 x 1000 mm. With so much space at hand you will make your shower an unforgettable experience.

No matter if you enjoy your shower alone or together with Aqua Tecc® you combine comfort and spaciousness having more than enough room to fulfill a variety of individual needs. Whichever size you prefer you can count on the elegance and high quality of Aqua Tecc® shower trays.

Dimensions (l x w x h)	Article number	Color	Price*
800 x 800 x 35 mm	0300-000	White	232,00 EUR
900 x 800 x 35 mm	0300-001	White	252,00 EUR
900 x 900 x 35 mm	0300-002	White	263,00 EUR
1000 x 800 x 35 mm	0300-003	White	304,00 EUR
1000 x 900 x 35 mm	0300-004	White	355,00 EUR
1000 x 1000 x 35 mm	0300-005	White	386,00 EUR
1200 x 800 x 35 mm	0300-006	White	386,00 EUR
1200 x 900 x 35 mm	0300-007	White	407,00 EUR
1200 x 1000 x 35 mm	0300-008	White	469,00 EUR
1400 x 800 x 35 mm	0300-009	White	469,00 EUR
1400 x 900 x 35 mm	0300-010	White	510,00 EUR
1400 x 1000 x 35 mm	0300-011	White	536,00 EUR
1600 x 800 x 45 mm	0300-012	White	536,00 EUR
1600 x 900 x 45 mm	0300-013	White	556,00 EUR
1600 x 1000 x 45 mm	0300-014	White	603,00 EUR
1800 x 800 x 45 mm	0300-015	White	603,00 EUR
1800 x 900 x 45 mm	0300-016	White	664,00 EUR
1800 x 1000 x 45 mm	0300-017	White	690,00 EUR

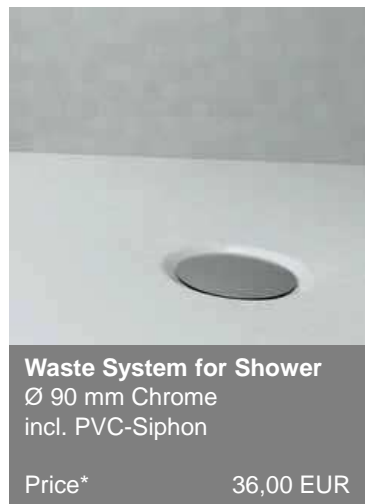

Frame set for	Article number	Price*
800 x 800 x 35 mm	0300-000-P	180,00 EUR
900 x 800 x 35 mm	0300-001-P	180,00 EUR
900 x 900 x 35 mm	0300-002-P	180,00 EUR
1000 x 800 x 35 mm	0300-003-P	180,00 EUR
1000 x 900 x 35 mm	0300-004-P	180,00 EUR
1000 x 1000 x 35 mm	0300-005-P	201,00 EUR
1200 x 800 x 35 mm	0300-006-P	201,00 EUR
1200 x 900 x 35 mm	0300-007-P	201,00 EUR
1200 x 1000 x 35 mm	0300-008-P	232,00 EUR
1400 x 800 x 35 mm	0300-009-P	232,00 EUR
1400 x 900 x 35 mm	0300-010-P	232,00 EUR
1400 x 1000 x 35 mm	0300-011-P	283,00 EUR
1600 x 800 x 45 mm	0300-012-P	283,00 EUR
1600 x 900 x 45 mm	0300-013-P	283,00 EUR
1600 x 1000 x 45 mm	0300-014-P	283,00 EUR
1800 x 800 x 45 mm	0300-015-P	283,00 EUR
1800 x 900 x 45 mm	0300-016-P	283,00 EUR
1800 x 1000 x 45 mm	0300-017-P	283,00 EUR

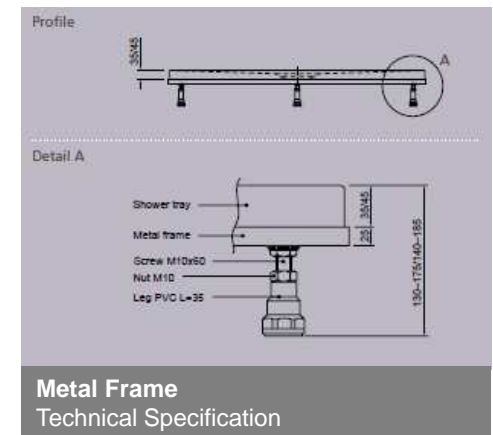

**I. General Provisions**

1. All legal relations between the Knief & Co GmbH (hereinafter referred to as „KCO“) and its contract partners in connection with supplies and / or services as well as offers of KCO shall be solely governed by these General Terms and Conditions. All contracts, KCO closes with its contract partners (hereinafter referred to as „Customer“) on the goods and services offered by KCO shall be subject to these General Terms and Conditions.

2. These General Terms and Conditions shall also apply to all future deliveries, services or offers to the Customer, even if they are not specifically agreed to again.

3. Terms and Conditions of the Customer or third parties are only valid insofar as KCO has expressly agreed to them in writing, regardless of whether the Customers' orders are executed without reservation.

**II. Offer and Conclusion of Contract**

1. All offers of KCO are non-binding and noncommittal, unless they are explicitly marked as binding or contain a specific acceptance period. Otherwise, the contract only comes into effect if KCO provides the Customer with written confirmation in relation to the order or a delivery within two weeks after receiving the order.

2. The legal relationship between KCO and the Customer is governed by the written contract or the written confirmation of the order, upto and including these General Terms and Conditions. Oral arrangements are legally non-binding.

3. No variation or addition to the contract or to these General Terms and Conditions shall be binding unless confirmed in writing and signed by one of the CEO's of KCO. Other employees or agents of KCO are not authorized to make agreements differing from the written contract or from these General Terms and Conditions.

4. To comply with the written form, the transmission by means of telecommunications, in particular by fax or e-mail, is sufficient if a copy of the signed statement is sent to the other contract party.

5. Unless otherwise agreed in writing, all documentation of the supply items and services (for example, dimensions, weight, loading capacity, tolerances, composition) as well as the illustrations and drawings thereof are only approximations so long as it has not been stipulated in the contract that exact details are required. They are not guaranteed characteristics, but a description or labelling of the delivery. KCO reserves the right to make any changes to the specifications of the supplies which are required to conform to any applicable statutory requirements or which include technical improvements, which do not materially affect their quality of performance.

**III. Prices, payment and offsets.**

1. All prices are quoted in Euro and given on an ex works basis, unless agreed otherwise. The Customer shall be liable to pay the VAT at the rate and in the manner from time to time prescribed by law. For export deliveries the currently valid „INCOTERMS“ apply.

2. Except as otherwise agreed in writing, the Customer shall be liable to pay KCO's charges for transport.

3. Unless quoted as a fixed price in writing, all prices are subject to the list price in force at the time of supply, or subject to individual agreements.

4. Payments shall be made in full to KCO's accounting department without any deduction. The day of payment is deemed to be the day the money is credited to KCO's accounts. A payment shall only be deemed to have been made when KCO has disposal over the amount. Unless otherwise agreed in writing, cheques and bills of exchange only apply as payment when honoured immediately after receipt of the invoice. All bank transaction costs shall be immediately borne by the Customer. If the Customer fails to make any payment on the due date then KCO shall be entitled to charge the Customer interest on the amount unpaid at the rate of 5% from the due date until payment is made in full. In case of default, the possibility to claim higher interest rates and additional damages shall remain unaffected.

5. Regardless of other terms, payments are initially set off against costs, then against interest and then used to settle the oldest principal debt.

6. The Customer may only offset payments against any money owing from KCO if its claims are undisputed or legally valid. The Customer has a right of retention of payment only as long as the counterclaim is based on the same contractual relationship and insofar as KCO does not hold a security, e.g a bank guarantee.

7. If KCO in its reasonable opinion determines after concluding a contract that the Customer's credit worthiness is unsatisfactory, KCO reserves the right to demand immediate payment or collateral security. KCO shall be entitled to withdraw from the contract or to suspend any further deliveries. In this case the Customer has no claim for damage. If the Customer fails to make a payment or, in the case of its filing for insolvency, all invoices become due immediately.

**IV. Delivery**

1. Deliveries shall be at the discretion of KCO ex-works of KCO.

2. Unless otherwise expressly agreed in writing, dates and deadlines for deliveries and services are non-binding. If shipping has been agreed, the delivery deadlines and dates refer to the moment of transfer to the shipper, carrier or other contracted third party transporter. 3. If the Customer does not fulfill its obligations under the contract in time, times set shall be extended reasonably.

4. In non-observance of the times set is due to:

- a) force majeure,
  - b) any other unforeseen event (such as breakdowns of all kinds, energy shortages, strikes, lawful lockouts),
  - c) hindrances attributable to German or otherwise applicable rules at KCO or at one of its suppliers, such times set shall be extended accordingly, plus a reasonable lead time.
- Where there is a hindrance according to points 4a) to 4c) which makes the delivery fundamentally more difficult or impossible and as long as the hindrance is not of a temporary nature only, KCO and the Customer are entitled to rescind the contract. In such cases the Customer has no claim for damages. In other circumstances of transgressions of deadlines, the Customer will give KCO a reasonable extension of time for delivery beginning with the day of the incoming mail of the written notification regarding the period of delivery having been exceeded.

5. Partial deliveries are permissible at any time, provided

- a) this is reasonable for the customer as part of the contractual purpose,
- b) the Customer does not incur significant additional own expenses or costs to third parties, unless KCO agrees to assume these costs.

**V. Loading, shipping, packaging, insurance**

1. Loading and shipping shall be at the risk of the Customer.

2. KCO shall be free to determine the mode of shipment and the packaging at its reasonable discretion. KCO shall endeavor to take the Customer's preferences and interests into consideration as regards the mode of packaging and of the shipping route.

3. KCO shall not take back any transport or other packaging in accordance with the German Packaging Ordinance. The Customer is obliged to dispose of packaging at its own expense.

4. Only upon the Customer's request, KCO shall insure the delivery against risks and at the Customer's expense.

5. The risk of shipment shall be borne by the Customer, unless in the case of a compulsory redemption due to legal or contractual obligations of KCO.

**VI. Transfer of Risk**

1. The risk shall pass to the Customer as soon as the goods have been shipped or collected by the carrier, freight forwarder or otherwise agreed third party shipper. The handover of the dispatch person is effective with the commencement of the loading operations. This applies even for partial deliveries or if KCO carries out other services (for example, transport).

If the dispatch or delivery is delayed for reasons for which the Customer is responsible, the risk shall pass to the Customer on the day at which the delivery item is ready for dispatch or delivery and KCO has informed the Customer as such.

2. Storage costs after transfer of risk shall be borne by the Customer.

3. The Customer is obliged to inspect the Supplies immediately upon delivery and shall notify the carrier of any loss or damages. Such notification shall be certified from the carrier on the consignment note or any other relevant document and shall be sent to KCO within 2 days after notification.

**VII. Warranty**

1. The warranty period shall be two years upon delivery or, if acceptance is required, from acceptance onwards. This shall not apply to Customer's claims of damages based on damages of loss of life, bodily injury or health, and an intentionally or grossly negligent breach of contract on the part of KCO or its agents; in this cases they expire in accordance with the statutory provisions.

2. There shall be no warranty as long as the repair of defects becomes impossible or unacceptably difficult if the customer or a third party modifies or repairs the delivered Supplies without the consent of KCO, and in the case of faulty or negligent handling, improper storage and maintenance. If a remedy of defects is nonetheless acceptable, the Customer shall be responsible for additional costs.

3. The supply of used items agreed with the Customer in individual cases is done under exclusion of any warranty.

**VIII. Defects**

1. Ceramic, Acrylic and/or Solid Surface materials can contain crazes and color deviations. Furthermore, non-prime products can contain imperfections at the edges or on the surfaces. Such phenomena does not affect the value of the materials and do not constitute a defect. For natural materials, e.g. marble or natural stone in general, KCO shall be under no liability whatsoever in respect of variations in color, glass veins, hairline cracking and similar deviations of the material.

2. KCO's deliveries of bathtubs and shower trays made of sanitary acrylic and all K | STONE Solid Surface products meet the relevant technical requirements, arising from the CE conformity.

3. The delivery item must be carefully inspected immediately after delivery to the Customer or to a specific third party from him. KCO shall not be responsible for any obvious defects, any shortage, damage or discrepancy in Supplies that would have been recognized on an immediate, thorough investigation unless notified to KCO in writing within 5 working days of receipt of the Supplies by the Customer.

With regard to other significant defects, the delivered Supplies shall be deemed approved by the Customer if the notification was not given within 5 working days after the Customer became aware of the defect or could reasonably be expected to have become aware of the defect if the defect was in normal use for the Customer detectable at an earlier date. The Customer shall not refuse acceptance of Supplies due to insignificant defects.

The redemption of faultless Supplies can only be accepted after a previous written confirmation of KCO. KCO shall credit the Customer the amount of the invoice minus 30% of the net amount for examination and handling costs and the loss of profit.

4. Upon request of KCO, a contested KCO delivery item has to be returned carriage paid to KCO. If the notice of defect is justified, KCO shall reimburse the costs of the cheapest method of shipment. The Customer shall have no claim with respect to the extent that expenses are increased because the Supplies have been brought to another location than that of the intended use.

5. At its free discretion within a reasonable period of time, KCO shall be given the choice to repair or to replace the defective goods two times. If repair or replacement is unsuccessful, the Customer is entitled to rescind the contract or reasonably reduce the remuneration unless further attempts of rework are reasonable for both parties. The Customer shall have no claim if statutory provisions allow KCO to refuse reworks.

6. If KCO replaces items in compliance with its obligations, the replaced items become the property of KCO when they are removed or returned.

7. If KCO is to blame for a defect and for the failure of the repair, the Customer may demand compensation under the circumstances stipulated in clause X.

8. In case of defects of components of other manufacturers which KCO cannot remedy for reasons of licensing law or for factual reasons, KCO can choose between enforcing claims against the manufacturer and supplier on the account of the Customer or assigning these claims to the Customer. Claims against KCO exist only if the legal enforcement of the abovementioned claims against the manufacturer or the supplier was unsuccessful or hopeless, e.g. in the case of insolvency.

**IX. Industrial Property Rights and copyrights; Defects in Title**

1. Unless otherwise agreed between the parties, KCO shall provide the Supplies free from third parties' industrial property rights and copyrights with respect to the country of the place of delivery only.

2. In case of infringements of rights concerning Supplies delivered by KCO and which are from other manufacturers and upstream suppliers point VIII 7 and 8 shall apply mutatis mutandis.

**X. Claims for damages**

1. KCO is liable according to the mandatory statutory provisions if the customer asserts claims for damages based on intent or gross negligence, for guaranteed characteristics, for loss of life, bodily injury or damage of health.

2. KCO is not liable in cases of simple negligence by its corporate bodies, lawful representatives, salaried employees or other agents as long as there is no breach of an essential contractual obligation. An essential contractual obligation is an obligation on which the client

can and may rely. Essential contractual obligations include the obligation to deliver in a timely manner goods that are free of defects with regards to the conformity and suitability of use, legal deficiencies, advisory, protective, custodial and duty of care obligations that enable the client to use the item delivered in the contractually prescribed manner or whose purpose is to protect the lives and health of the client's personnel or the protection of his property from significant damage.

3. Claims for damages shall be limited to the foreseeable damage which is intrinsic to the contract, provided that no case of intent applies. KCO shall only be liable for indirect and consequential damages arising from or in connection with its performance under the contract if they were typically foreseeable.

4. The above exclusions and limitations of liability also apply to the same extent in favor of the corporate bodies, employees and other agents of KCO.

5. In so far as KCO provides technical information or acts as an adviser and this information or advice is not part of the contractually agreed scope of services owed by him, this is done free of charge and with the exclusion of any liability.

6. Unless otherwise provided for in the present General Terms and Conditions, the Customer has no claim for damages based on whatever legal reason.

**XI. Retention of Title**

1. The items pertaining to the Supplies ("Retained Goods") shall remain KCO's property until each and every claim KCO has against the Customer on account of the business relationship has been fulfilled. If the combined value of KCO's security interests exceeds the value of all secured claims by more than 20%, KCO shall release a corresponding part of the security interest if so requested by the Customer; KCO shall be entitled to choose which security interest it wishes to release.

2. For the duration of the retention of title, the Customer may not pledge the Retained Goods or use them as security.

3. Should the Customer resell Retained Goods, he hereby by way of security assigns to KCO his future claims under the resale including any ancillary rights and all balance claims against his customer without the need for subsequent special statements. If the Customer resells the Retained Goods together with other items without an individual price having been agreed, the Customer shall assign to KCO that portion of the total price which equals the price of the Retained Goods invoiced by KCO.

4. The Customer is entitled to process, amalgamate or combine the Retained Goods with other items. Processing is made for KCO. The Customer shall store the new item thus created for KCO, exercising the due care of a diligent business person. The new items are considered as Retained Goods.

KCO and the Customer agree that the Retained Goods which may be combined or amalgamated with other items that were not the property of KCO, now become co-owned by KCO. The share of co-ownership by KCO results from the ratio of the original Retained Goods to the value of the other goods at the time of blending or mixing. In this respect, the new items are considered as Retained Goods.

The provisions on the assignment of claims according to point 3 above shall also apply to the new item. The assignment, however, shall only apply to the amount corresponding to the value invoiced by KCO for the Retained Goods that have been processed, combined or amalgamated.

Where the Customer combines Retained Goods with real estate or movable goods, he shall, without any further declaration being necessary to this effect, also assign to KCO as security his claim to consideration for the combination, including all collateral rights for the prorata amount of the value the combined Retained Goods have on the other combined items at the time of the combination.

5. Until further notice the Customer may collect assigned claims relating to the resale. KCO is entitled to withdraw the Customer's permission to collect funds for good reason. In addition, KCO may, upon expiry of an adequate period of notice disclose the assignment,

realize the claims assigned and demand that the Customer informs its customers of the assignment.

6. The Customer shall inform KCO forthwith of any seizure or other act of intervention by third parties. If a reasonable interest can be proven, the Customer shall, without undue delay, provide KCO with the information and/or Documents necessary to assert the claims it has against its customers.

7. Where the Customer fails to fulfill its duties, e.g. defaults on payments, KCO shall be entitled to rescind the contract and take back the Retained Goods in the case of continued failure following expiry of a reasonable remedy period set by KCO. The statutory provisions providing that a remedy period is not needed shall be unaffected. The Customer shall be obliged to return the Retained Goods. The fact that KCO takes back Retained Goods and/ or exercises the retention of title, or has the Retained Goods seized, shall not be construed to constitute a rescission of the contract, unless KCO so expressly declares.

**XII. Jurisdiction and applicable law**

1. If the Customer is a businessman, or is a legal entity or a special fund organized under public law or has no general place of jurisdiction in Germany, the sole venue for all disputes arising directly or indirectly out of the contract shall be the corporate seat of KCO. However, KCO may also bring an action at the Customer's place of business.

2. The contract and its interpretation shall be governed only by German law. The United Nations Convention on Contracts for the International Sale of Goods dated 11 April 1980 (CISG) does not apply.

**XIII. Severability Clause**

The contract and these General Terms and Conditions remain binding even if individual terms or provisions are void or unenforceable. In place of the invalid or unenforceable provision, or to fill a contractual gap, such valid and enforceable provision shall apply which reflects as closely as possible the commercial intention of the parties as regards the invalid, unenforceable or missing provision.

In case of discrepancies between different language versions of these General Terms and Conditions, the German language version shall take precedence.

as of September 2016