

SIRO
SOLUZIONI PER L'AMBIENTE BAGNO

2017
CATALOGO

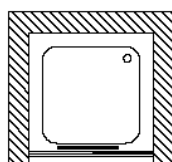

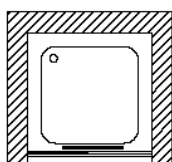

Porta scorrevole a due ante
Apertura laterale ad anta scorrevole,
una fissa ed una apribile

Two panels door
Lateral opening with sliding panel;
one fixed and one can be opened

Articolo Article	Estensibilità (cm) Extension	Finitura Pannelli Panels Finishing	Codice EAN EAN Code	Codice EAN EAN Code	KL (€)
B-SC220/DX	98-100	VTR	//	//	456
B-SC220/DX		VRF	//	//	555
B-SC220/SX		VTR	//	//	456
B-SC220/SX		VRF	//	//	555
B-SC222/DX	118-120	VTR	//	//	496
B-SC222/DX		VRF	//	//	595
B-SC222/SX		VTR	//	//	496
B-SC222/SX		VRF	//	//	595
B-SC224/DX	138-140	VTR	//	//	536
B-SC224/DX		VRF	//	//	635
B-SC224/SX		VTR	//	//	536
B-SC224/SX		VRF	//	//	635
DF	Trattamento anticalcare				80

Prezzi IVA esclusa
Price VAT not included

Il modello si compone di n° colli di spedizione: 1
The model is composed of n° packings: 1



Prodotti speciali: Prezzo di listino + 40%
Special products: Price List + 40%

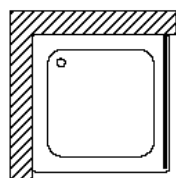
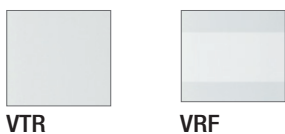
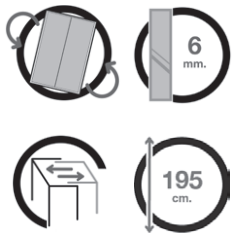

Parete fissa
E' possibile formare cabine doccia a 2 lati

Fixed panel
to form 2 sides shower enclosures

Articolo Article	Estensibilità (cm) Extension	Finitura Pannelli Panels Finishing	Codice EAN EAN Code	Codice EAN EAN Code	KL (€)
B-SC252/DX	78-80	VTR	//	//	178
B-SC252/DX		VRF	//	//	218
B-SC252/SX		VTR	//	//	178
B-SC252/SX		VRF	//	//	218
B-SC254/DX	88-90	VTR	//	//	198
B-SC254/DX		VRF	//	//	238
B-SC254/SX		VTR	//	//	198
B-SC254/SX		VRF	//	//	238
DF	Trattamento anticalcare				40

Prezzi IVA esclusa
Price VAT not included

Il modello si compone di n° colli di spedizione: 1
The model is composed of n° packings: 1



Prodotti speciali: Prezzo di listino + 40%
Special products: Price List + 40%



VTR

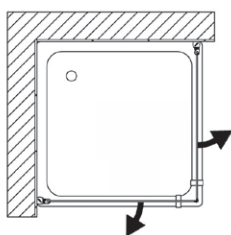

Lato per angolo a due ante a battente
Apertura verso l'esterno

One side for corner shower enclosure
Two outward opening pivot doors

Articolo Article	Estensibilità (cm) Extension	Finitura Pannelli Panels Finishing	Codice EAN EAN Code	KL (€)
B-TE509/M (1 lato - 1 side)	64-68	VTR	8019002094797	515
B-TE510/M (1 lato - 1 side)	74-78	VTR	8019002094803	535
B-TE511/M (1 lato - 1 side)	87-88	VTR	8019002094810	550

N.B. I valori della tabella prezzi si riferiscono ad un singolo lato: sommare l'importo dei due codici con la misura desiderata per ottenere il prezzo totale di un box doccia ad angolo quadrato o rettangolare.

Prezzi IVA esclusa
Price VAT not included

Abbinamento possibile con parete fissa (un solo lato)

Possible combination with fixed panel (only one side)

JAZZ

Lato per angolo a due ante a battente, apertura verso l'esterno

R-RIC1092
€ 90

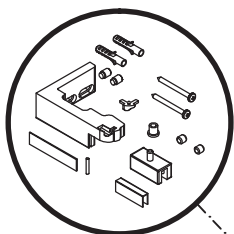

RIC1266
€ 25

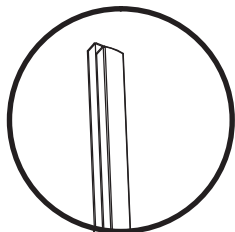

R-RIC227
€ 29

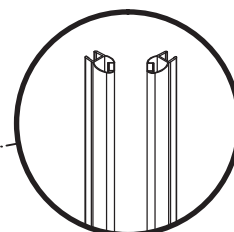

R-RIC1197.KL
€ 30

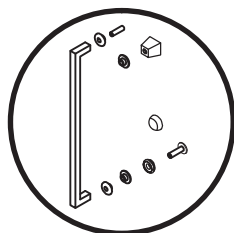

R-RIC241
€ 15

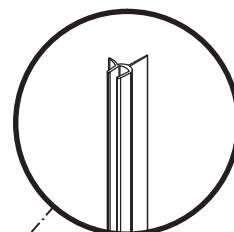

RIC1115C
€ 20

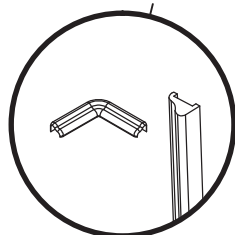

RIC1102
€ 9

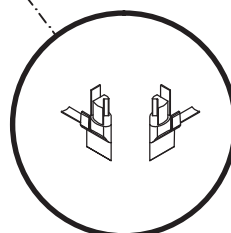

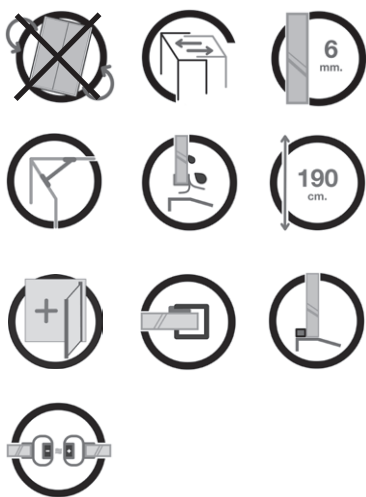

VTR

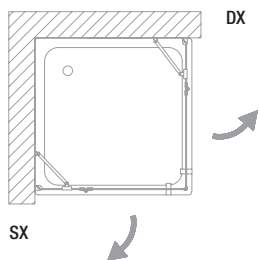

Lato per angolo a due ante a battente
Apertura verso l'esterno

One side for corner shower enclosure
Two outward opening pivot doors

Articolo Article	Estensibilità (cm) Extension	Finitura Pannelli Panels Finishing	Codice EAN EAN Code	L1 (€)	Codice EAN EAN Code	KL (€)
B-NP409/DX (1 lato - 1 side)	76,5-79	VTR	8019002107367	510	8019002107343	575
B-NP409/SX (1 lato - 1 side)			8019002107374		8019002107350	
B-NP412/DX (1 lato - 1 side)	85-87,5	VTR	8019002107404	525	8019002107381	585
B-NP412/SX (1 lato - 1 side)			8019002107411		8019002107398	
B-NP413/DX (1 lato - 1 side)	95-97,5	VTR	8019002107442	530	8019002107428	595
B-NP413/SX (1 lato - 1 side)			8019002107459		8019002107435	
B-NP415/DX (1 lato - 1 side)	115-117,5	VTR	8019002107480	550	8019002107466	615
B-NP415/SX (1 lato - 1 side)			8019002107497		8019002107473	

N.B. I valori della tabella prezzi si riferiscono ad un singolo lato: sommare l'importo dei due codici con la misura desiderata per ottenere il prezzo totale di un box doccia ad angolo quadrato o rettangolare.

Prezzi IVA esclusa
Price VAT not included

Abbinamento possibile con parete fissa (un solo lato) - Possible combination with fixed panel (only one side)

Il modello si compone di n° colli di spedizione: 1
The model is composed of n° packings: 1



Prodotti speciali: Prezzo di listino + 40%
Special products: Price List + 40%

ARPA

Lato per angolo a due ante a battente, apertura verso l'esterno

ANGOLI

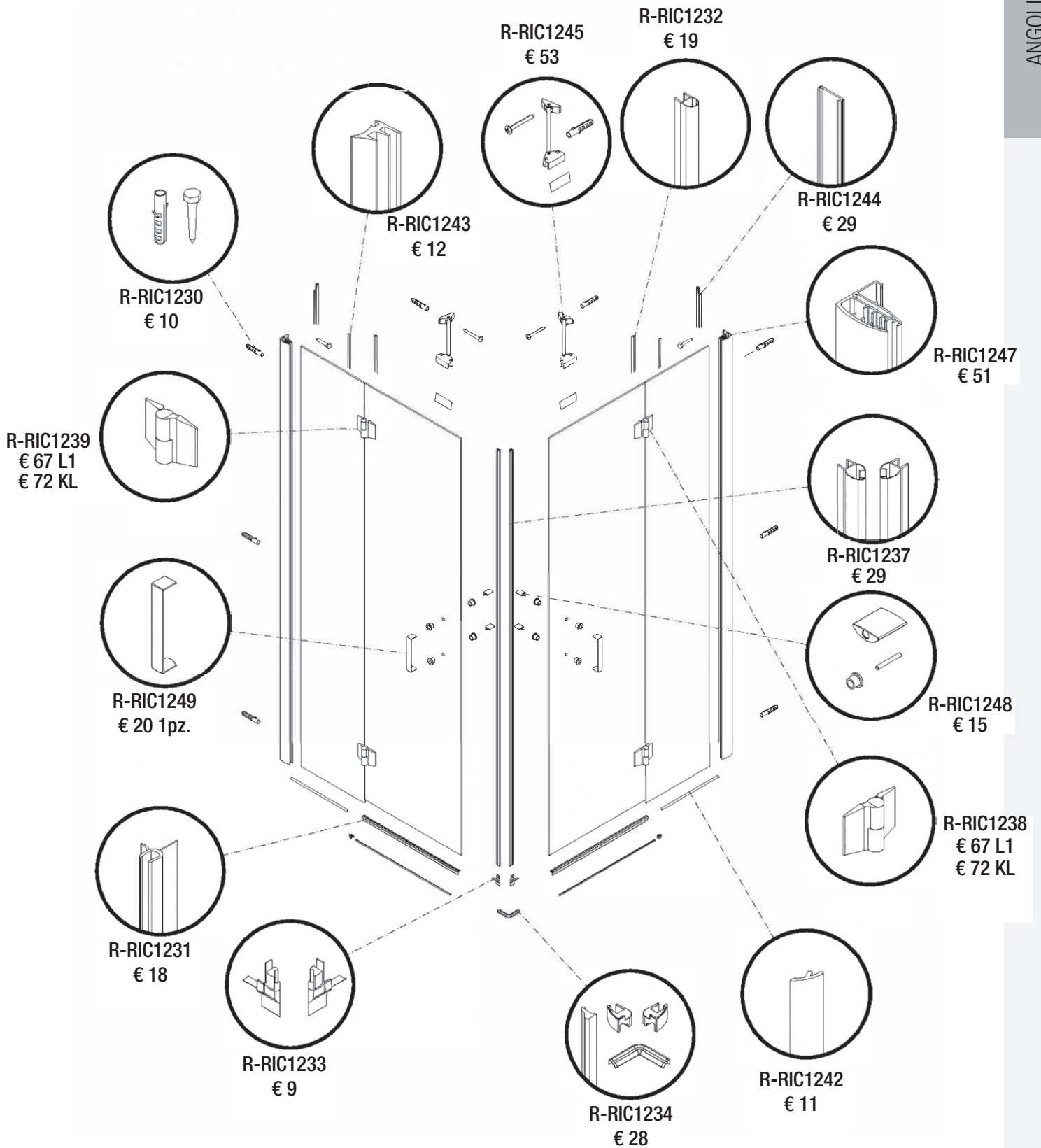

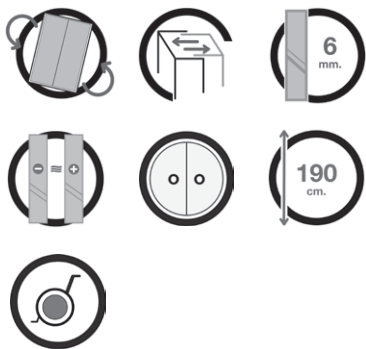

VTR

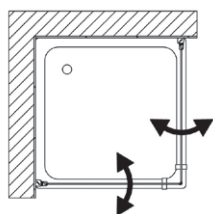

Lato per angolo divisibile
Apertura ad ante battenti
apribili verso l'interno e l'esterno

One side for corner shower enclosure
Opening with sliding panels,
two fixed and two can be opened

Articolo Article	Estensibilità (cm) Extension	Finitura Pannelli Panels Finishing	Codice EAN EAN Code	KL (€)
B-ID110 (1 lato - 1 side)	76,5-78,5	VTR	8019002085788	440
B-ID111 (1 lato - 1 side)	86,5-88,5	VTR	8019002085795	465

N.B. I valori della tabella prezzi si riferiscono ad un singolo lato: sommare l'importo dei due codici con la misura desiderata per ottenere il prezzo totale di un box doccia ad angolo quadrato o rettangolare.

Prezzi IVA esclusa
Price VAT not included

SOUL

Lato angolo divisibile con due ante a battente, apertura verso l'interno e l'esterno

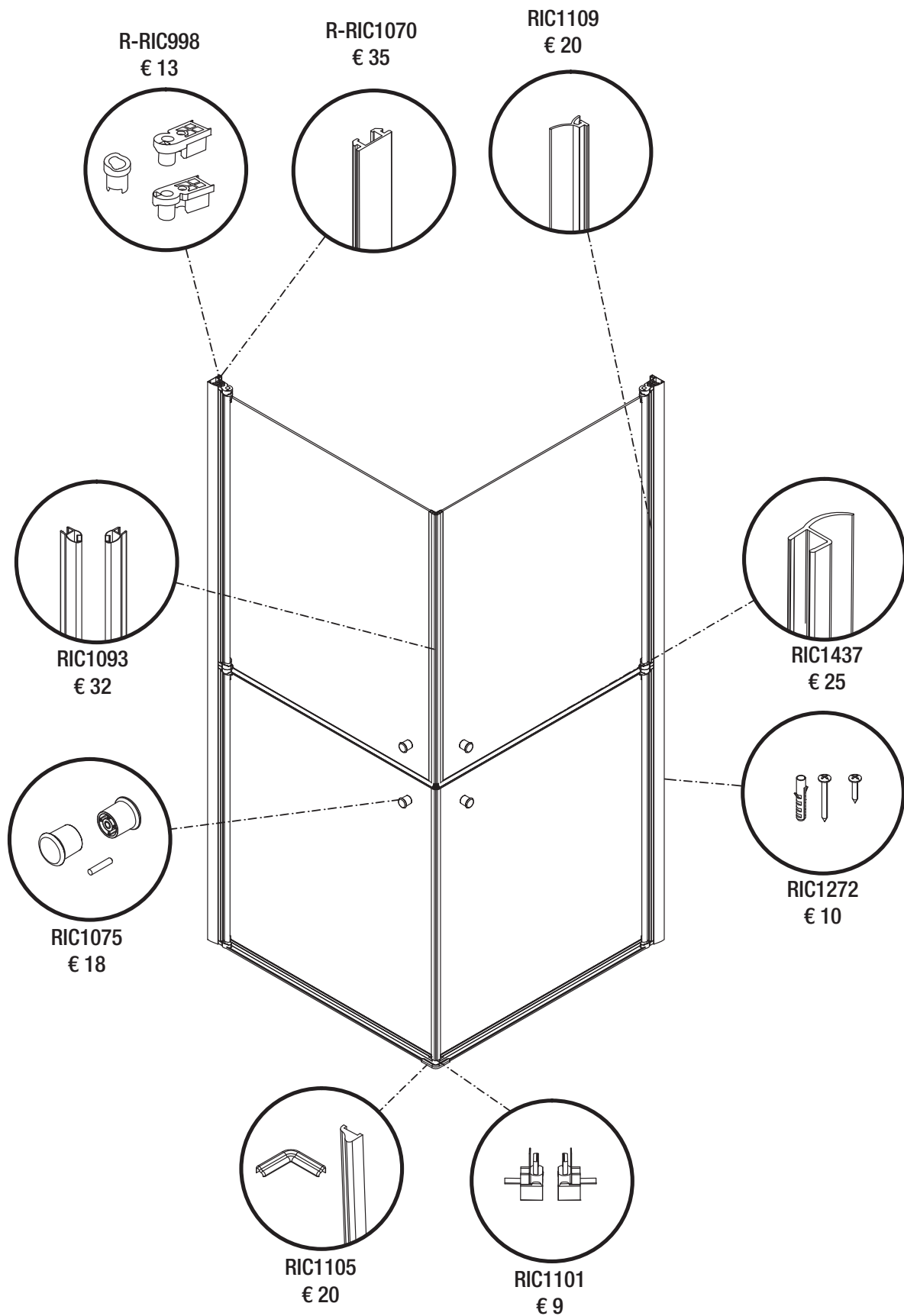

ORCHESTRA

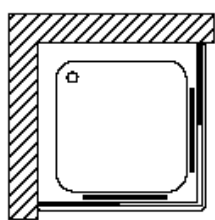

Lato per angolo scorrevole a quattro ante
Apertura ad ante scorrevoli,
due fisse e due apribili

One side for corner shower enclosure
Opening with sliding panels,
two fixed and two can be opened

Articolo Article	Estensibilità (cm) Extension	Finitura Pannelli Panels Finishing	Codice EAN EAN Code	L1 (€)	Codice EAN EAN Code	KL (€)
B-OC16 (1 lato - 1 side)	67-69	VTR	8019002105035	300	8019002105066	300
		VST	8019002105028	325	8019002105059	325
		VSQ	8019002105011	330	8019002105042	330
B-OC17 (1 lato - 1 side)	72-74	VTR	8019002105097	310	8019002105127	310
		VST	8019002105080	335	8019002105110	335
		VSQ	8019002105073	350	8019002105103	350
B-OC18 (1 lato - 1 side)	77-79	VTR	8019002105158	320	8019002105189	320
		VST	8019002105141	345	8019002105172	345
		VSQ	8019002105134	360	8019002105165	360
B-OC20 (1 lato - 1 side)	87-89	VTR	8019002105196	330	8019002105240	330
		VST	8019002105202	355	8019002105233	355
		VSQ	8019002105219	365	8019002105226	365
B-OC21 (1 lato - 1 side)	97-99	VTR	8019002105271	340	8019002105301	340
		VST	8019002105264	355	8019002105295	355
		VSQ	8019002105257	375	8019002105288	375

N.B. I valori della tabella prezzi si riferiscono ad un singolo lato: sommare l'importo dei due codici con la misura desiderata per ottenere il prezzo totale di un box doccia ad angolo quadrato o rettangolare.

Prezzi IVA esclusa
Price VAT not included

Il modello si compone di n° colli di spedizione: 1
The model is composed of n° packings: 1



Prodotti speciali: Prezzo di listino + 40%
Special products: Price List + 40%

ORCHESTRA

Lato angolo scorrevole a quattro ante, due fisse e due apribili

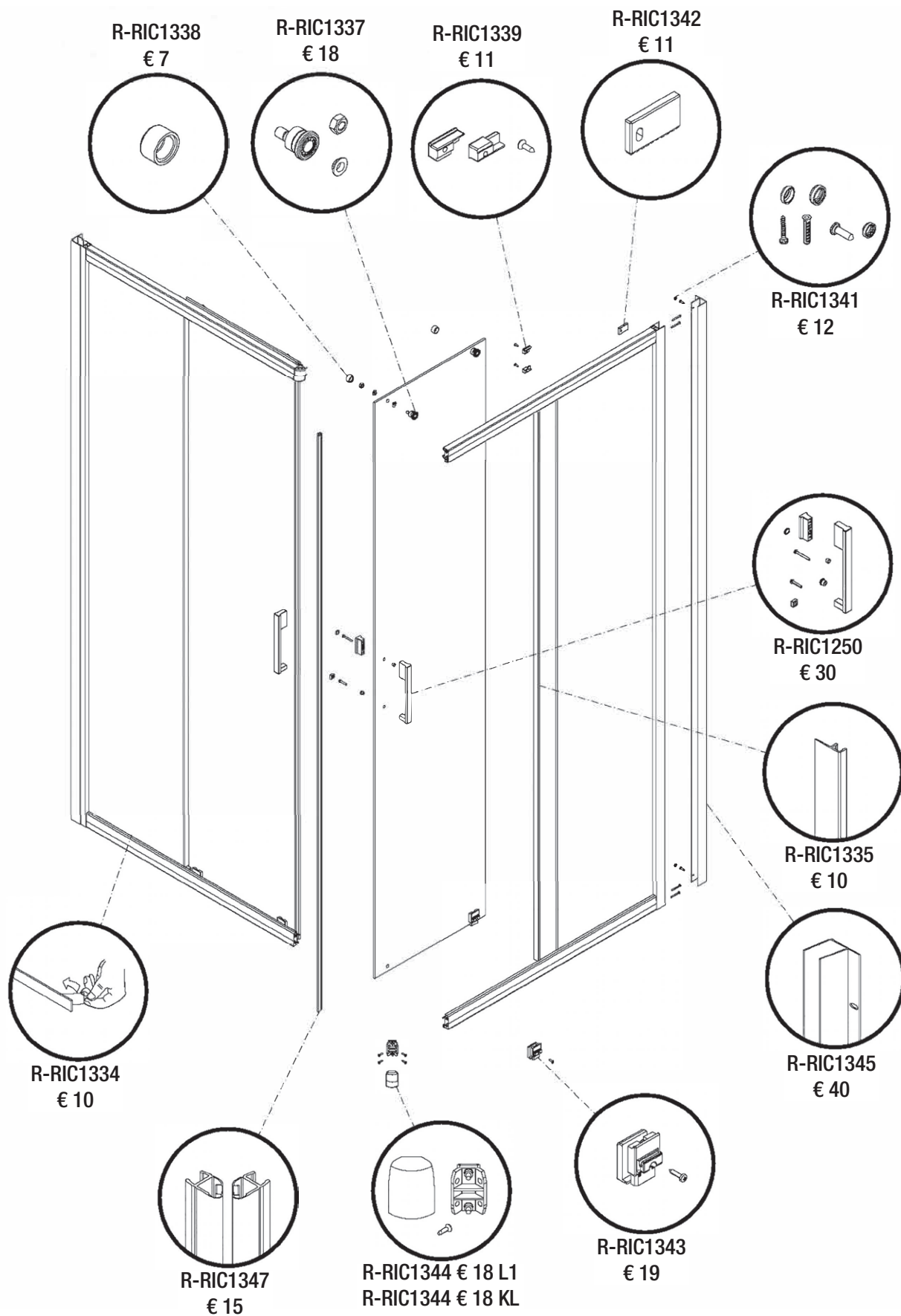

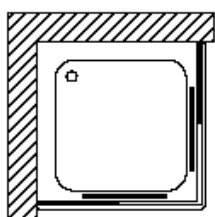
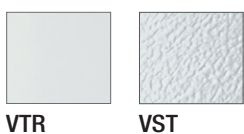
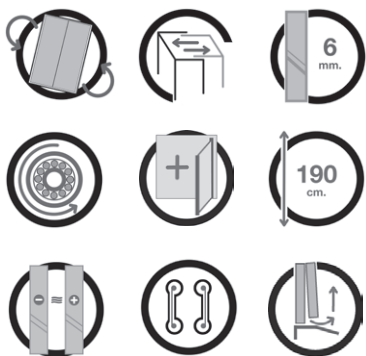

Lato per angolo scorrevole a quattro ante
Apertura ad ante scorrevoli,
due fisse e due apribili

One side corner shower enclosure
Opening with sliding panels,
two fixed and two can be opened

Articolo Article	Estensibilità (cm) Extension	Finitura Pannelli Panels Finishing	Codice EAN EAN Code	L1 (€)	Codice EAN EAN Code	KL (€)
B-EX817/M (1 lato - 1 side)	69-71	VTR			8019002083975	270
		VST	8019002083968	255		
B-EX818/M (1 lato - 1 side)	79-81	VTR			8019002083999	285
		VST	8019002083982	270		
B-EX823/M (1 lato - 1 side)	89-91	VTR			8019002082633	300
		VST	8019002084002	290		
B-EX880/M (1 lato - 1 side)	99-101	VTR			8019002087522	320
		VST	8019002087539	310		

N.B. I valori della tabella prezzi si riferiscono ad un singolo lato: sommare l'importo dei due codici con la misura desiderata per ottenere il prezzo totale di un box doccia ad angolo quadrato o rettangolare.

Prezzi IVA esclusa
Price VAT not included

Il modello si compone di n° colli di spedizione: 1
The model is composed of n° packings: 1

Prodotti speciali: NON DISPONIBILI
Special products: NOT AVAILABLE

MARACAS

Lato angolo scorrevole a quattro ante, due fisse e due apribili

R-RIC1098.L1
R-RIC1098.KL
€ 20

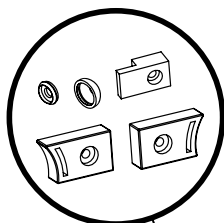

R-RIC1068.L1
R-RIC1098.KL
€ 18

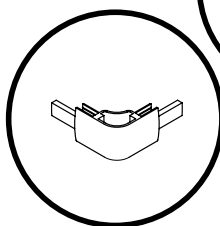

R-RIC1048.L1
R-RIC1048.KL
€ 28

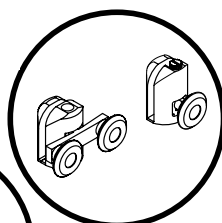

R-RIC1066
€ 12

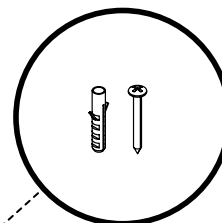

R-RIC1060.L1
R-RIC1060.KL
€ 40

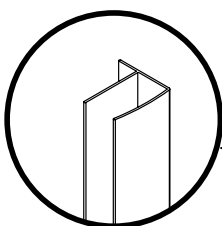

R-RIC1067
€ 30
(n° 1 pz.)

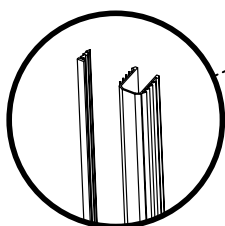
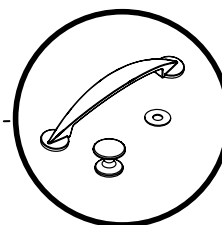

R-RIC1095
€ 30

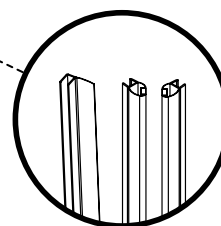

R-RIC1046
€ 40

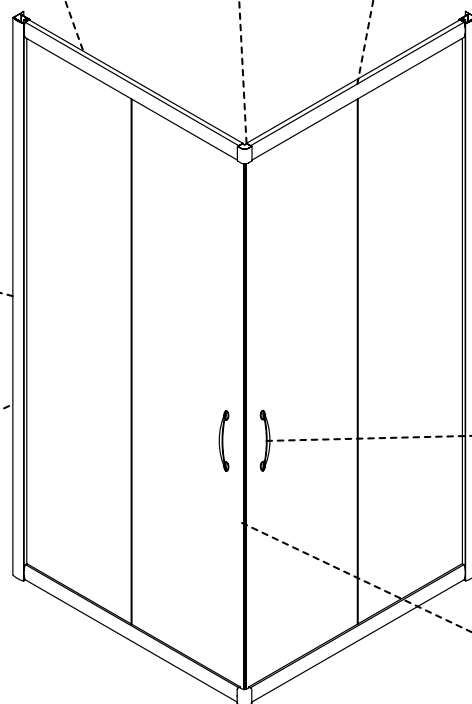

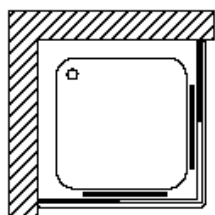
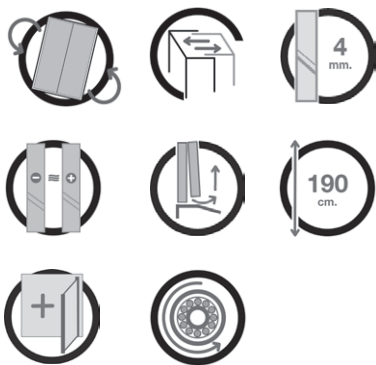

Angolo scorrevole a quattro ante
Apertura ad ante scorrevoli,
due fisse e due apribili

Corner shower enclosure
Opening with sliding panels,
two fixed and two can be opened

Articolo Article	Estensibilità (cm) Extension	Finitura Pannelli Panels Finishing	Codice EAN EAN Code	KL (€)
B-IMPA80	70-80	CH	8019002101105	270
		GR	8019002102485	300
		SK	8019002102560	305
B-IMPA7090	60-70/80-90	CH	8019002101112	300
B-IMPA80100	70-80/90-100	GR	8019002102508	330
		SK	8019002102621	345

Prezzi IVA esclusa
Price VAT not included

VIOLINO

Angolo scorrevole a quattro ante, due fisse e due apribili

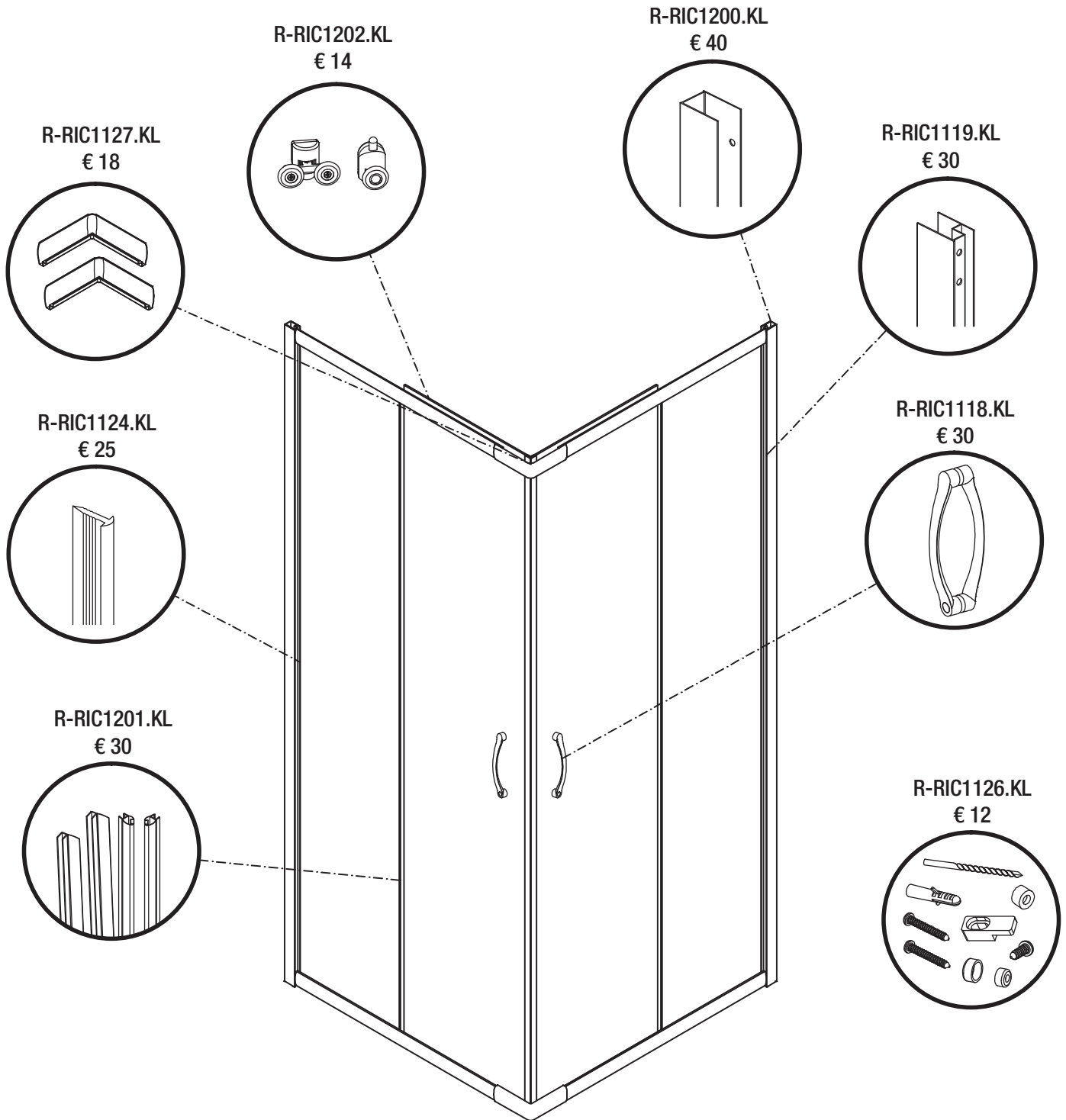

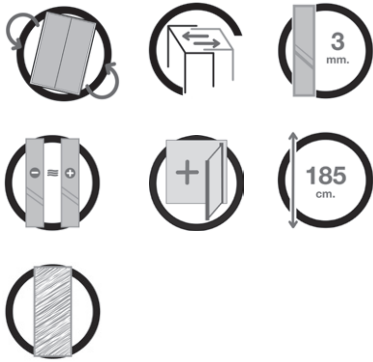

VST

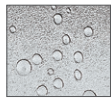

C

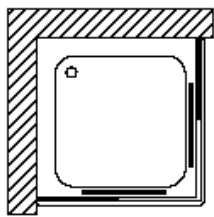

Angolo scorrevole a quattro ante
Apertura ad ante scorrevoli,
due fisse e due apribili

Corner shower enclosure
Opening with sliding panels,
two fixed and two can be opened

Articolo Article	Estensibilità (cm) Extension	Finitura Pannelli Panels Finishing	Codice EAN EAN Code	L1 (€)
B-GC501	65-75	VST	8019002045669	285
		C	8019002047984	245
B-GC502	70-80	VST	8019002048011	300
		C	8019002045805	260
B-GC503	80-90	VST	8019002048042	315
		C	8019002048028	275
B-GC510	65-75/80-90	VST	8019002045546	315
		C	8019002048059	275

Prezzi IVA esclusa
Price VAT not included

Il modello si compone di n° colli di spedizione: 1
The model is composed of n° packings: 1



Prodotti speciali: Prezzo di listino + 40%
Special products: Price List + 40%

FIATI

Angolo scorrevole a quattro ante, due fisse e due apribili

R-RIC186
€ 15

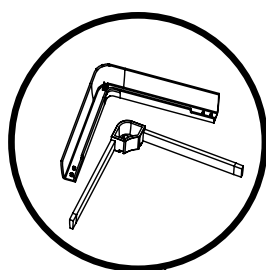

RIC1385L01
€ 24

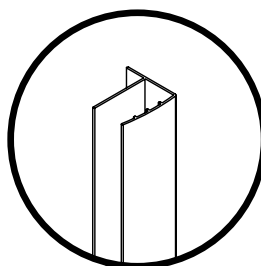

R-RIC206
€ 30

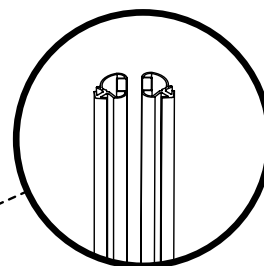

R-RIC103
€ 10

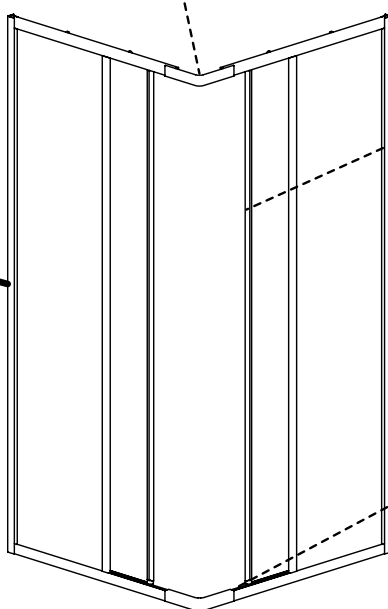
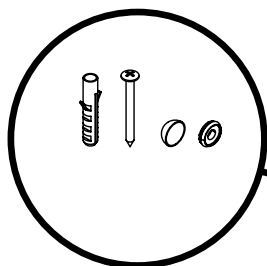

R-RIC987
€ 10

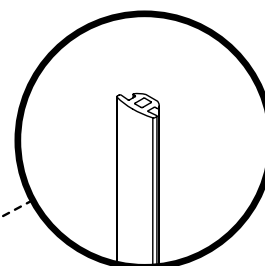

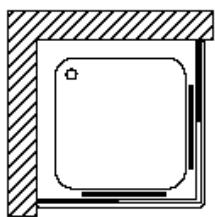
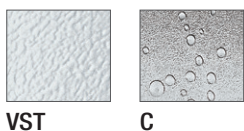
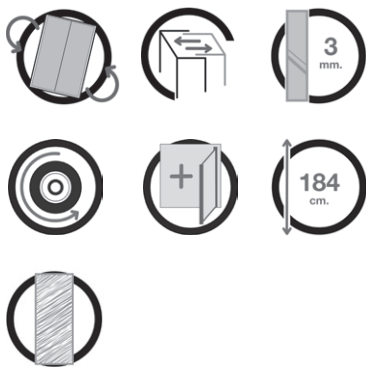

Angolo scorrevole a quattro ante
Apertura ad ante scorrevoli,
due fisse e due apribili

Corner shower enclosure
Opening with sliding panels,
two fixed and two can be opened

Articolo Article	Estensibilità (cm) Extension	Finitura Pannelli Panels Finishing	Codice EAN EAN Code	L1 (€)
B-SI2005VST	68-79	VST	8019002041791	245
B-SI2005C		C	8019002041876	190
B-SI2005VST2	78-89	VST	8019002042057	255
B-SI2005C2		C	8019002041906	205
B-SI2005VST3	68-79 / 78-89	VST	8019002042064	255
B-SI2005C3		C	8019002041913	205

Prezzi IVA esclusa
Price VAT not included

OPERA

Angolo scorrevole a quattro ante, due fisse e due apribili

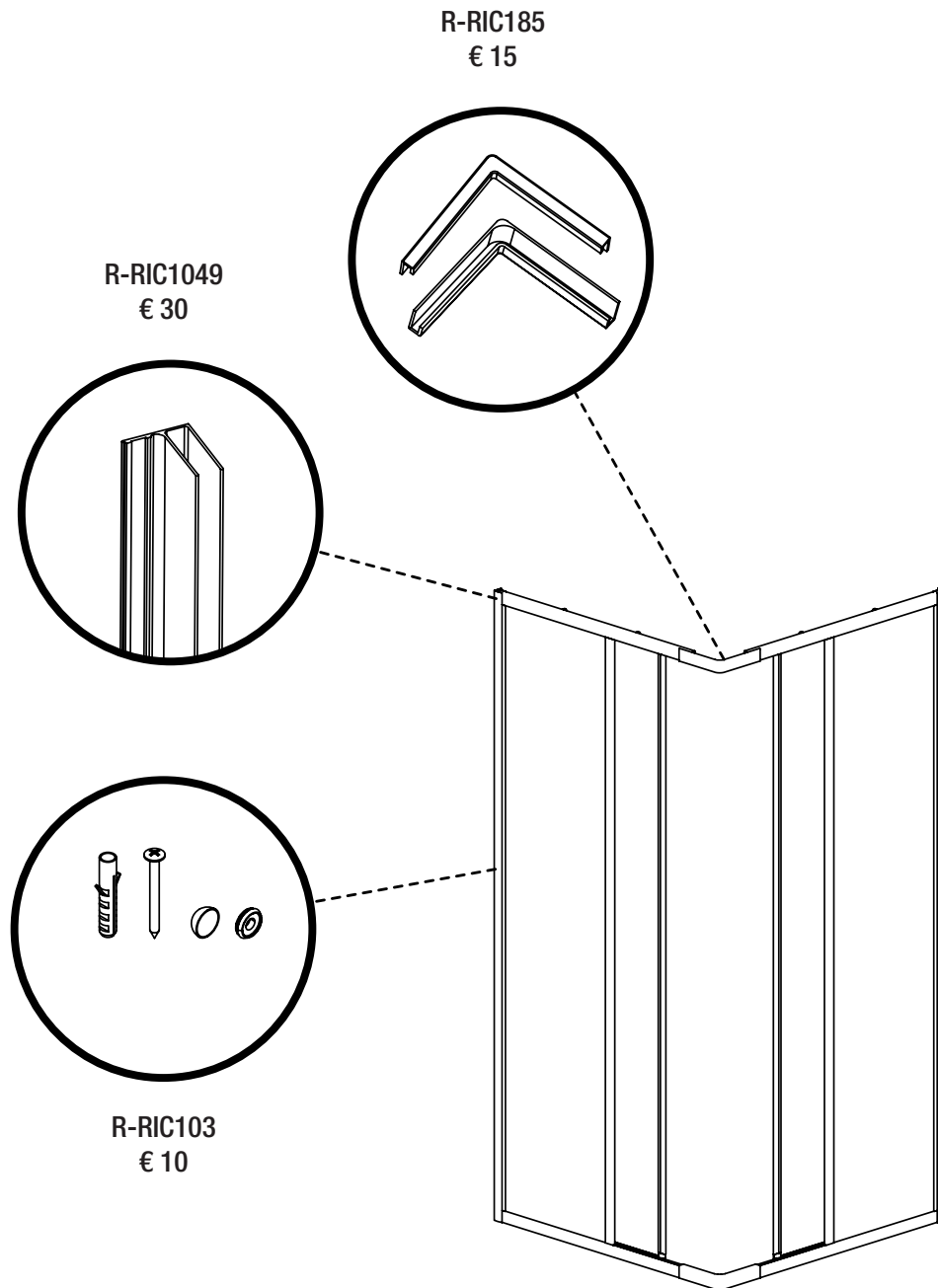

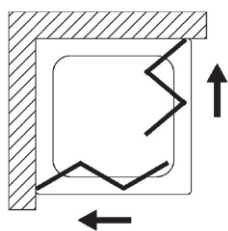
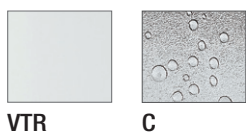
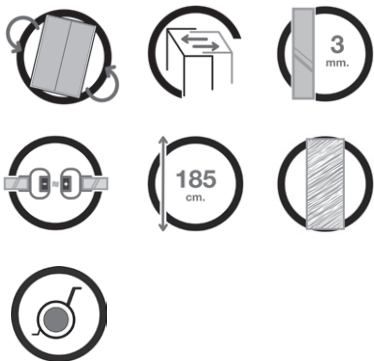

Angolo con ante a soffietto
Apertura ad ante a soffietto ripiegabili

Corner enclosure two bifolding panels
Folding opening inwards and outwards with hinges at 180°.

Articolo Article	Estensibilità (cm) Extension	Finitura Pannelli Panels Finishing	Codice EAN EAN Code	L1 (€)
B-ID103	68-72	VTR	8019002069566	615
		C	8019002085740	565
B-ID104	76-80	VTR	8019002069573	640
		C	8019002085757	580
B-ID105	88-92	VTR	8019002081957	670
		C	8019002085764	615
B-ID106	65-75 / 80-90	VTR	8019002081964	650
		C	8019002085771	595

Prezzi IVA esclusa
Price VAT not included

Il modello si compone di n° colli di spedizione: 1
The model is composed of n° packings: 1

Prodotti speciali: NON DISPONIBILI
Special products: NOT AVAILABLE

SOUL

Angolo con ante a soffietto, aperture con ante ripiegabili

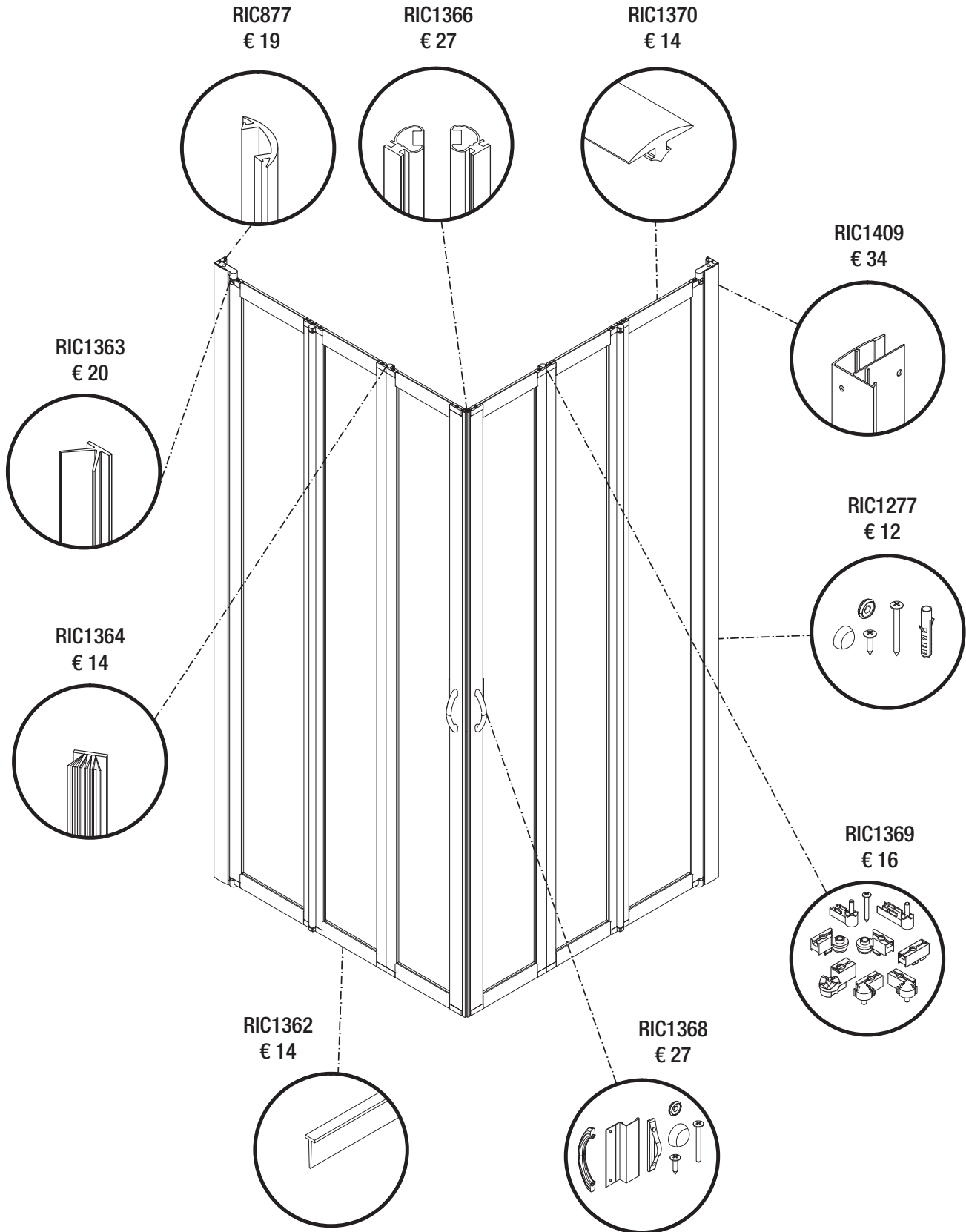

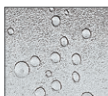
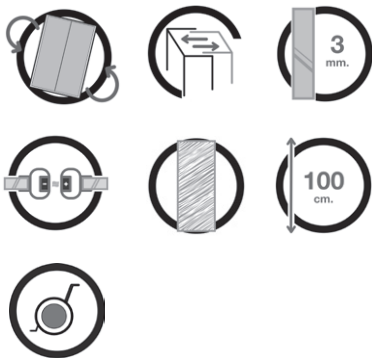

C

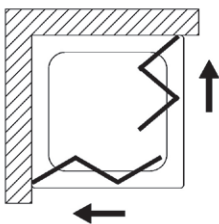

Angolo con ante a soffietto
Apertura ad ante a soffietto ripiegabili

Corner enclosure two bifolding panels
Folding opening inwards and outwards with hinges at 180°.

Articolo Article	Estensibilità (cm) Extension	Finitura Pannelli Panels Finishing	Codice EAN EAN Code	L1 (€)
B-ID101	76-80	C	8019002081971	370
B-ID102	88-92	C	8019002081988	380

Prezzi IVA esclusa
Price VAT not included

SOUL

Angolo con ante a soffietto, apertura con ante ripiegabili

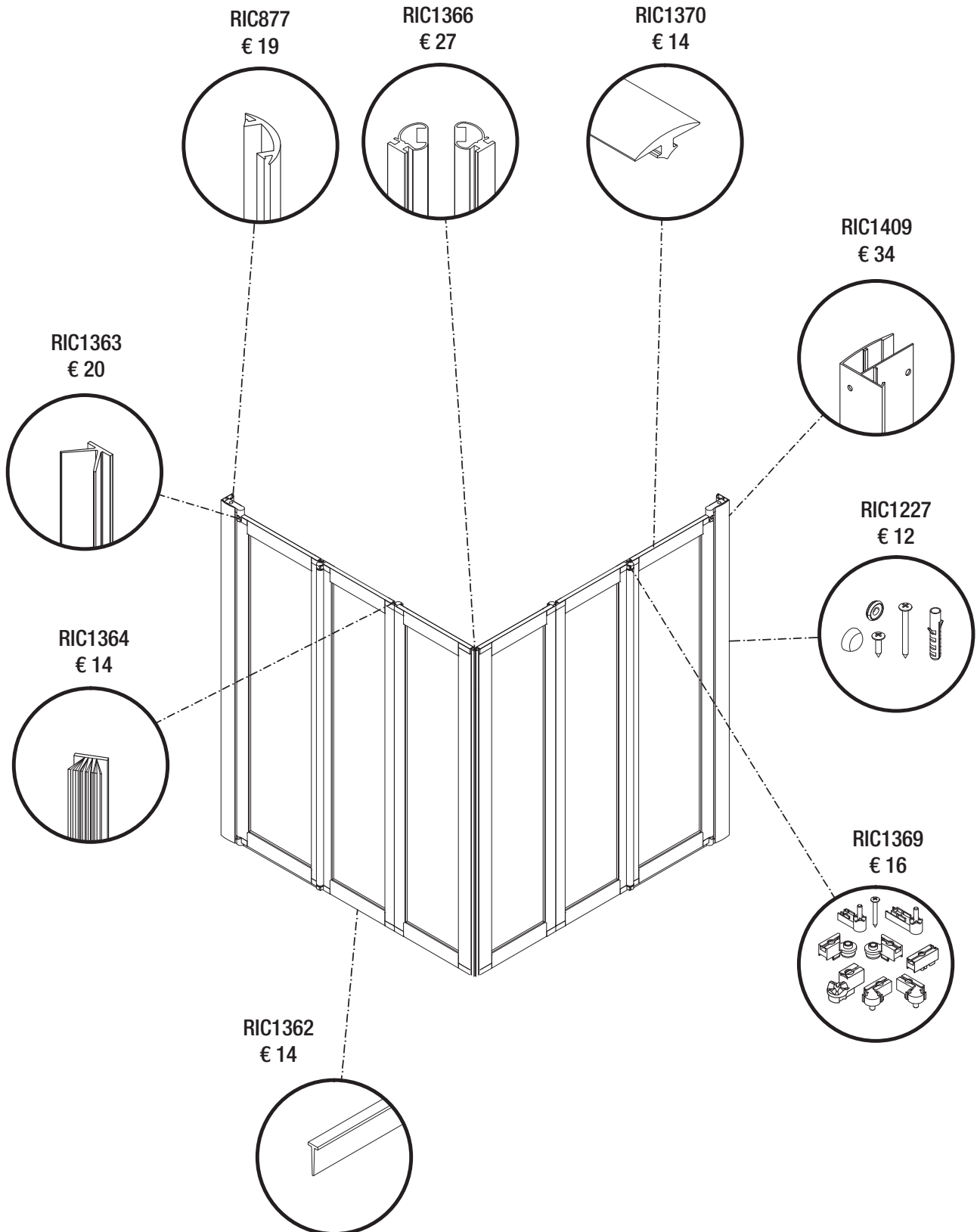

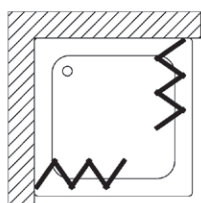
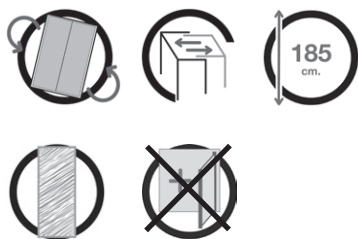

Box angolare PVC riducibile
Apertura ad ante pieghevoli

Corner unit PVC reducible
Opening with folding panels

Articolo Article	Estensibilità (cm) Extension	Finitura Pannelli Panels Finishing	Codice EAN EAN Code	L1 (€)
B-PV100	65-75	PVC	8019002053923	210
B-PV101	70-80	PVC	8019002053930	210
B-PV102	60-70/80-90	PVC	8019002053947	225
B-PV103	80-90	PVC	8019002053954	230
B-PV104	70-80/90-100	PVC	8019002053961	245
B-PV105	60-70/110-120	PVC	8019002053978	245
B-PV106	90-100	PVC	8019002053985	255
B-PV107	70-80/110-120	PVC	8019002077943	255

Non abbinabile a parete fissa
Not to match with fixed panel

Prezzi IVA esclusa
Price VAT not included

Questo prodotto è riducibile alla misura desiderata, basta tagliare il binario ed eliminare le stecche fino ad ottenere la misura desiderata.
This product can be reduced to the desired size, simply cut the track and eliminate the sticks until you get the desired size.

Il modello si compone di n° colli di spedizione: 1
The model is composed of n° packings: 1

Prodotti speciali: NON DISPONIBILI
Special products: NOT AVAILABLE

SIPARIO

Angolare con ante a soffietto, aperture con ante riducibili

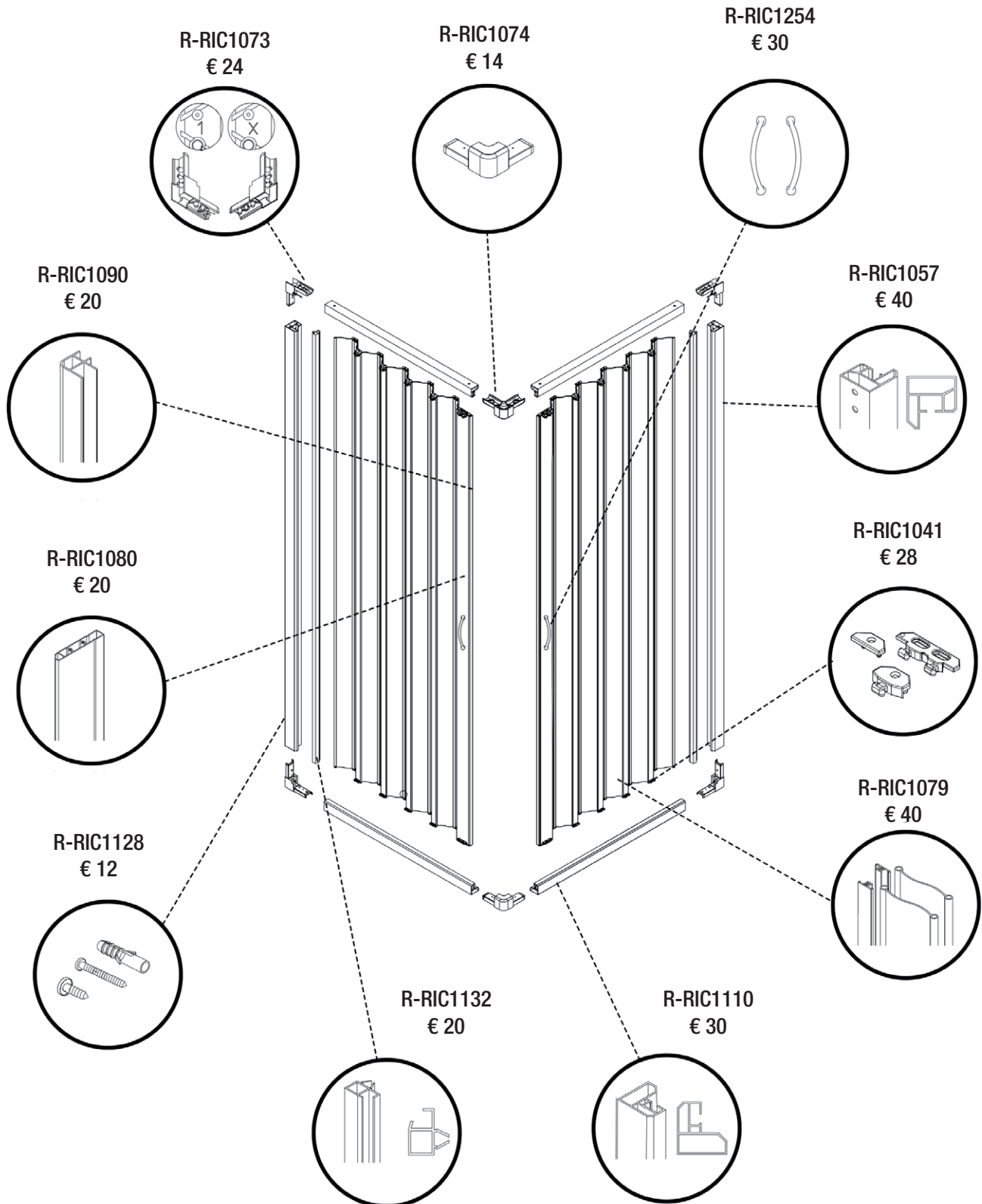

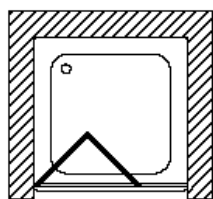

Porta a due ante a soffietto
Apertura con ante pieghevoli verso l'interno

Bifolding door
Inwards folding doors opening

Articolo Article	Estensibilità (cm) Extension	Finitura Pannelli Panels Finishing	Codice EAN EAN Code	L1 (€)	Codice EAN EAN Code	KL (€)
B-0C07	67-71	VTR	8019002104731	370	8019002104762	430
		VST	8019002104724	400	8019002104755	460
		VSQ	8019002104717	410	8019002104748	470
B-0C08	72-76	VTR	8019002104793	375	8019002104823	435
		VST	8019002104786	405	8019002104816	465
		VSQ	8019002104779	420	8019002104809	480
B-0C09	77-81	VTR	8019002104854	385	8019002104885	440
		VST	8019002104847	410	8019002104878	470
		VSQ	8019002104830	430	8019002104861	490
B-0C10	87-91	VTR	8019002104915	390	8019002104946	450
		VST	8019002104908	420	8019002104939	480
		VSQ	8019002104992	440	8019002104922	500
B-0C11	97-101	VTR	8019002104977	400	8019002105004	460
		VST	8019002104960	430	8019002104991	490
		VSQ	8019002104953	450	8019002104984	510

Prezzi IVA esclusa
Price VAT not included

Il modello si compone di n° colli di spedizione: 1
The model is composed of n° packings: 1



Prodotti speciali: Prezzo di listino + 40%
Special products: Price List + 40%

ORCHESTRA

Porta a due ante a soffietto, apertura con ante pieghevoli verso l'interno

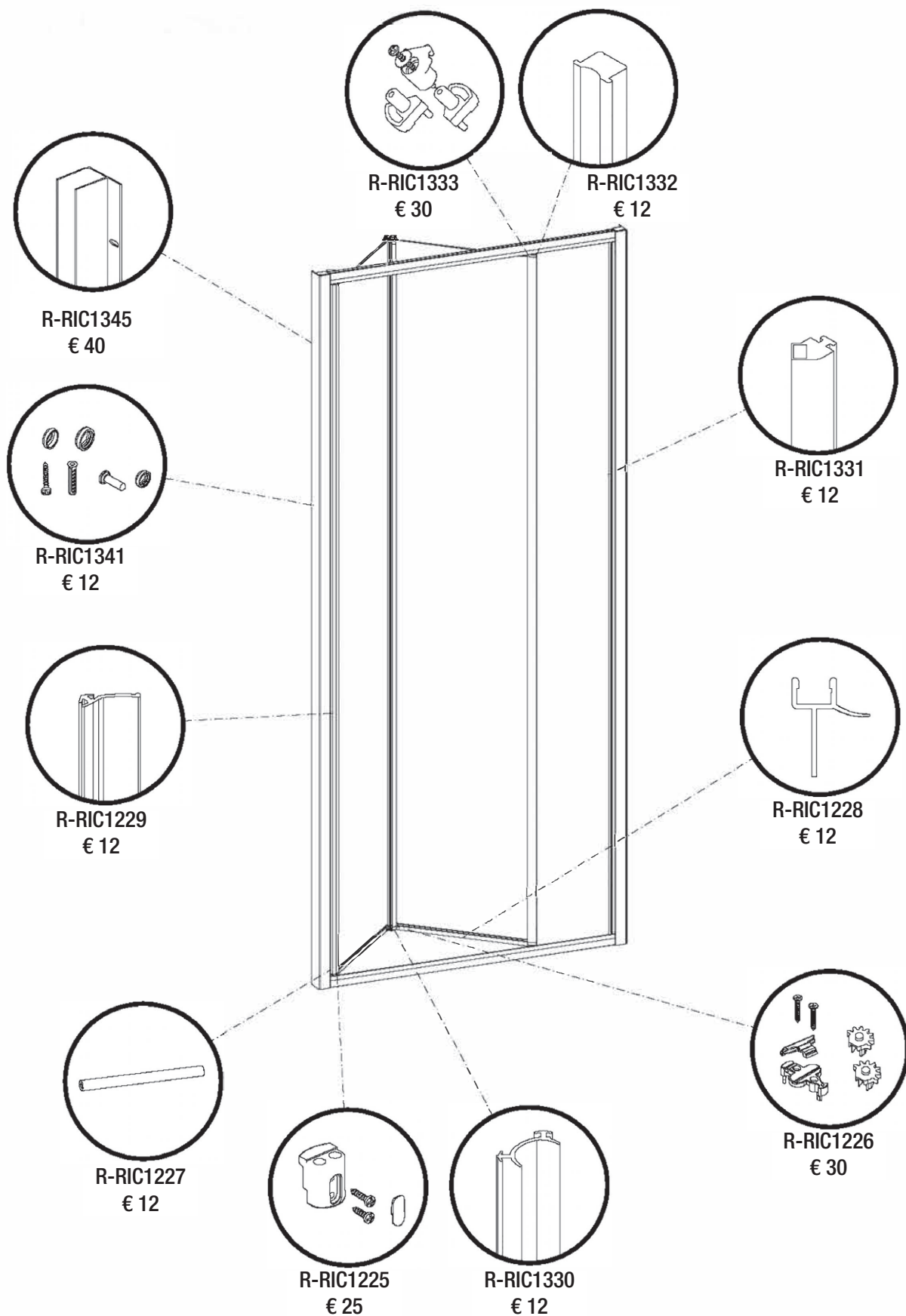

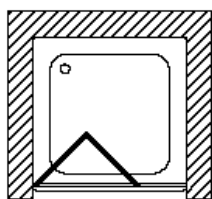
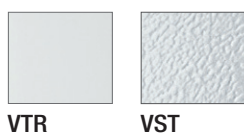
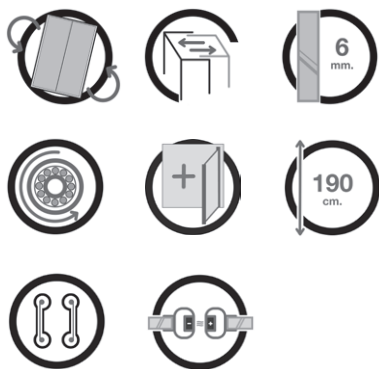

Porta a due ante a soffietto
Apertura con ante pieghevoli verso l'interno

Bifolding door
Inwards folding doors opening

Articolo Article	Estensibilità (cm) Extension	Finitura Pannelli Panels Finishing	Codice EAN EAN Code	L1 (€)	Codice EAN EAN Code	KL (€)
B-EX831	68-71	VTR			8019002068583	390
		VST	8019002068620	365		
B-EX832	78-81	VTR			8019002068590	425
		VST	8019002068637	395		
B-EX833	88-91	VTR			8019002068606	450
		VST	8019002068644	420		

Prezzi IVA esclusa
Price VAT not included

Il modello si compone di n° colli di spedizione: 1
The model is composed of n° packings: 1

Prodotti speciali: NON DISPONIBILI
Special products: NOT AVAILABLE

MARACAS

Porta a due ante a soffietto, apertura con ante pieghevoli verso l'interno

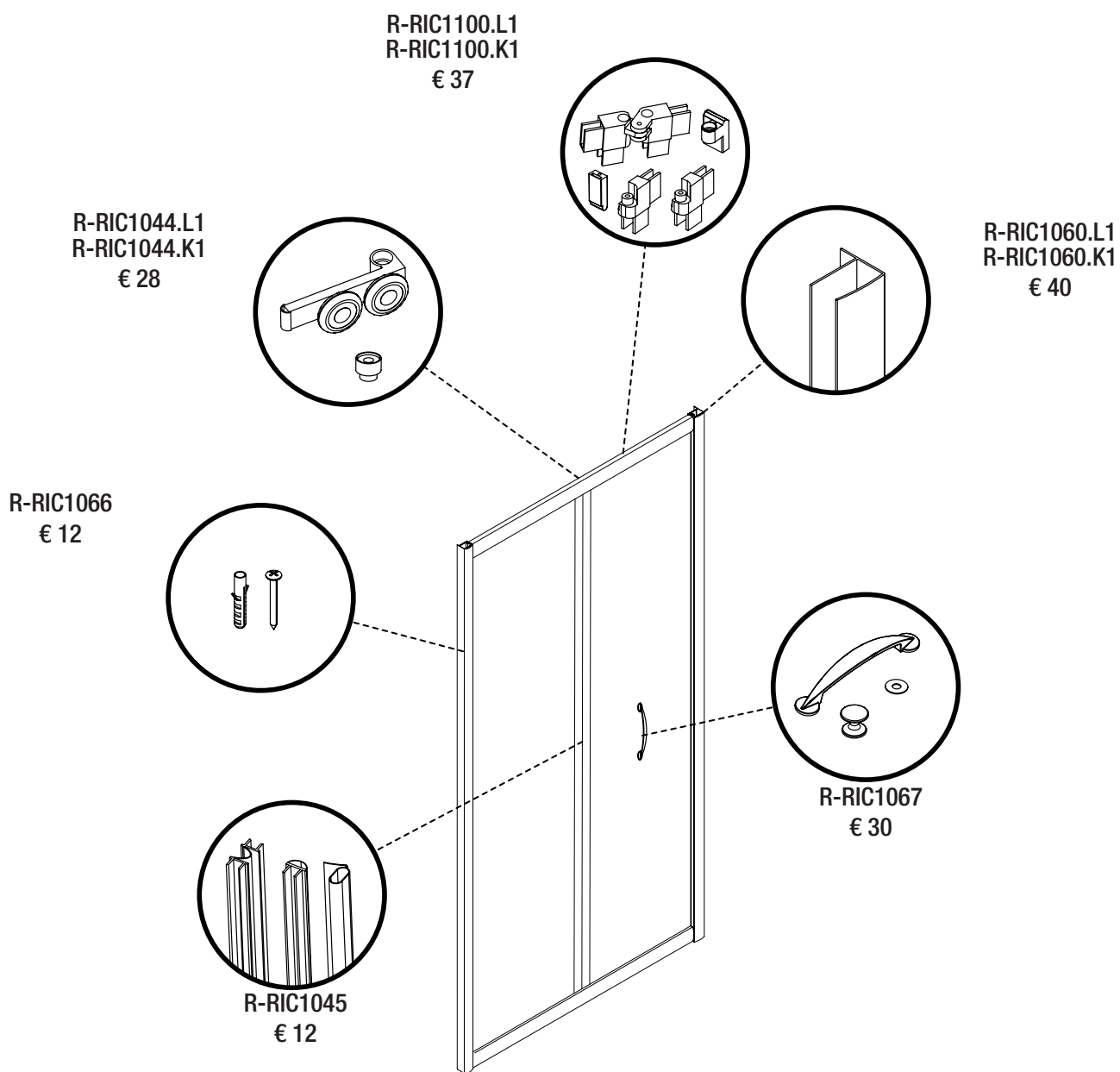

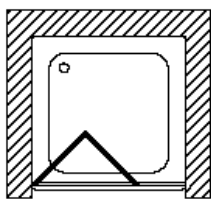
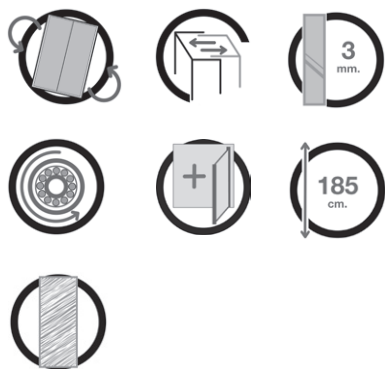

Porta a due ante a soffietto
Apertura con ante pieghevoli verso l'interno

Bifolding door
Inwards folding doors opening

Articolo Article	Estensibilità (cm) Extension	Finitura Pannelli Panels Finishing	Codice EAN EAN Code	L1 (€)	Codice EAN EAN Code	KL (€)
B-PA660	69-73	VTR	8019002083579	335	8019002083586	395
		VST	8019002083593	365	8019002083609	420
		VFS	8019002084569	430	8019002084125	490
		S	8019002083555	290	8019002083562	355
B-PA662	77-81	VTR	8019002083630	345	8019002083647	410
		VST	8019002083654	370	8019002083661	430
		VFS	8019002084576	440	8019002084132	505
		S	8019002083616	300	8019002083623	365
B-PA664	85-89	VTR	8019002083692	350	8019002083708	420
		VST	8019002083715	380	8019002083722	440
		VFS	8019002084583	450	8019002084149	515
		S	8019002083678	315	8019002083685	375
B-PA667	97-101	VTR	8019002083753	370	8019002083760	435
		VST	8019002083777	390	8019002083784	455
		VFS	8019002084590	465	8019002084187	530
		S	8019002083739	330	8019002083746	395

Prezzi IVA esclusa
Price VAT not included

Il modello si compone di n° colli di spedizione: 1
The model is composed of n° packings: 1



Prodotti speciali: Prezzo di listino + 40%
Special products: Price List + 40%

TENORE

Porta a due ante a soffietto, apertura con ante pieghevoli verso l'interno

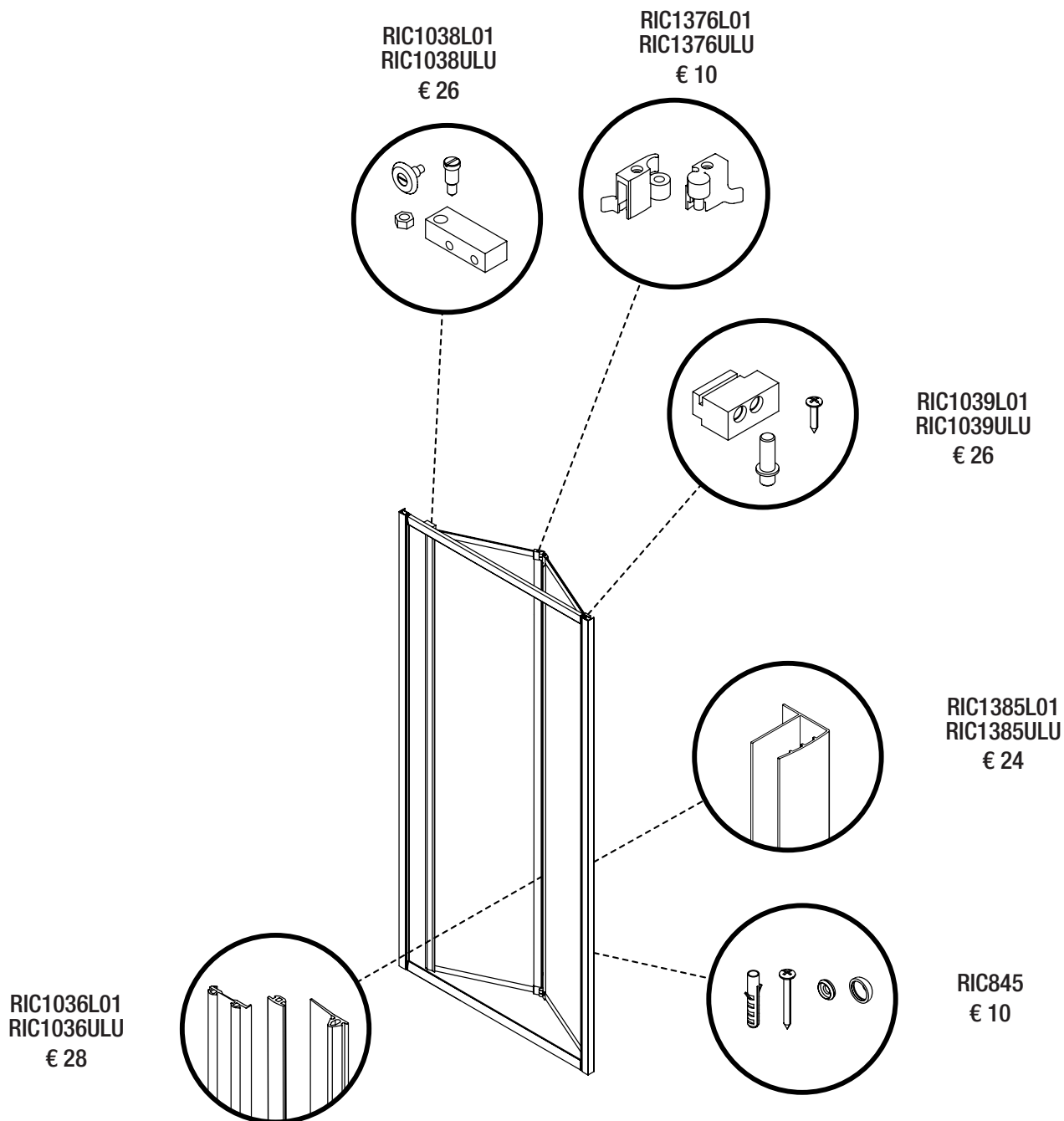

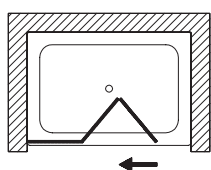
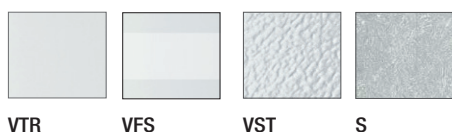
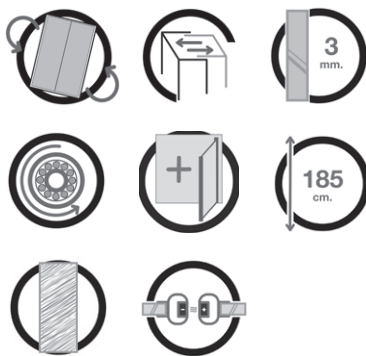

Porta a soffietto in linea
Apertura con ante pieghevoli verso l'interno

Bifolding door online
Inwards folding doors opening

Articolo Article	Estensibilità (cm) Extension	Finitura Pannelli Panels Finishing	Codice EAN EAN Code	L1 (€)	Codice EAN EAN Code	KL (€)
B-PA670	97-101	VTR	8019002084958	400	8019002084996	475
		VST	8019002084965	435	8019002085009	515
		VFS	8019002084972	550	8019002085016	590
		S	8019002084941	370	8019002084989	445
B-PA668	107-111	VTR	8019002084668	420	8019002084156	495
		VST	8019002084675	455	8019002084163	535
		VFS	8019002084682	570	8019002084170	610
		S	8019002084651	390	8019002084699	465
B-PA669	117-121	VTR	8019002084712	445	8019002084194	515
		VST	8019002084729	475	8019002084200	560
		VFS	8019002084736	590	8019002084217	630
		S	8019002084705	410	8019002084743	495

Prezzi IVA esclusa
Price VAT not included

Il modello si compone di n° colli di spedizione: 1
The model is composed of n° packings: 1



Prodotti speciali: Prezzo di listino + 40%
Special products: Price List + 40%

TENORE

Porta a soffietto con parete fissa in linea, apertura con ante pieghevoli verso l'interno

RIC1376L01
RIC1376ULU
€ 10

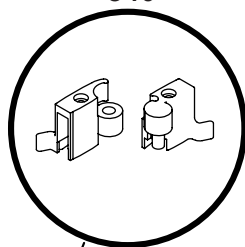

RIC1038L01
RIC1038ULU
€ 26

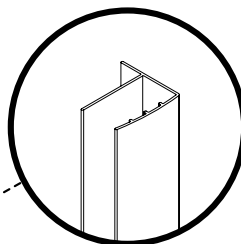
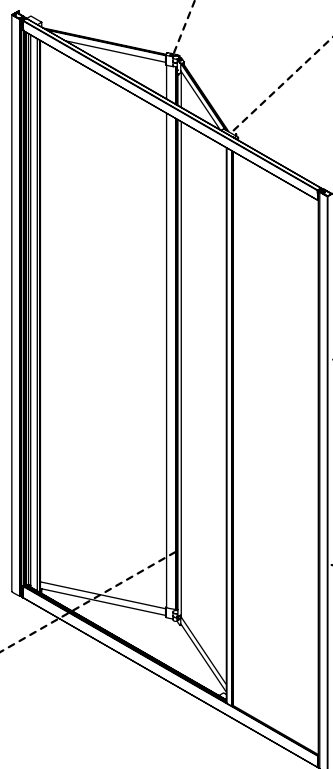
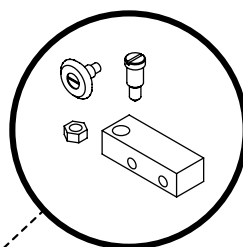

RIC1385L01
RIC1385ULU
€ 24

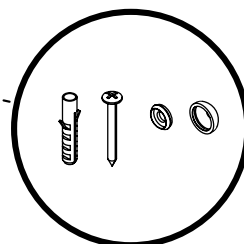

RIC845
€ 10

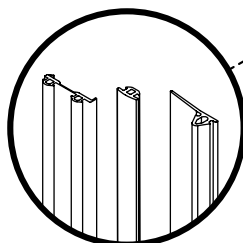

RIC1036L01
RIC1036ULU
€ 28



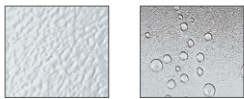
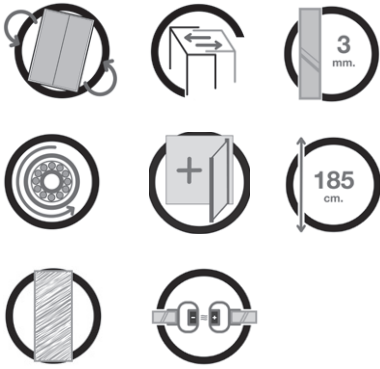

VST

C

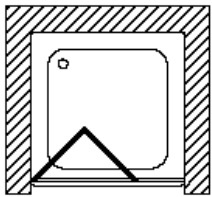

Porta a due ante a soffietto
Apertura con ante pieghevoli verso l'interno

Bifolding door
Inwards folding doors opening

Articolo Article	Estensibilità (cm) Extension	Finitura Pannelli Panels Finishing	Codice EAN EAN Code	L1 (€)
B-GC560	69-73	VST	8019002048219	350
		C	8019002048196	270
B-GC561	73-77	VST	8019002048240	360
		C	8019002048226	280
B-GC562	77-81	VST	8019002048271	370
		C	8019002048257	290
B-GC564	85-89	VST	8019002048301	380
		C	8019002048288	300

Prezzi IVA esclusa
Price VAT not included

Il modello si compone di n° colli di spedizione: 1
The model is composed of n° packings: 1



Prodotti speciali: Prezzo di listino + 40%
Special products: Price List + 40%

FIATI

Porta a due ante a soffietto, apertura con ante pieghevoli verso l'interno

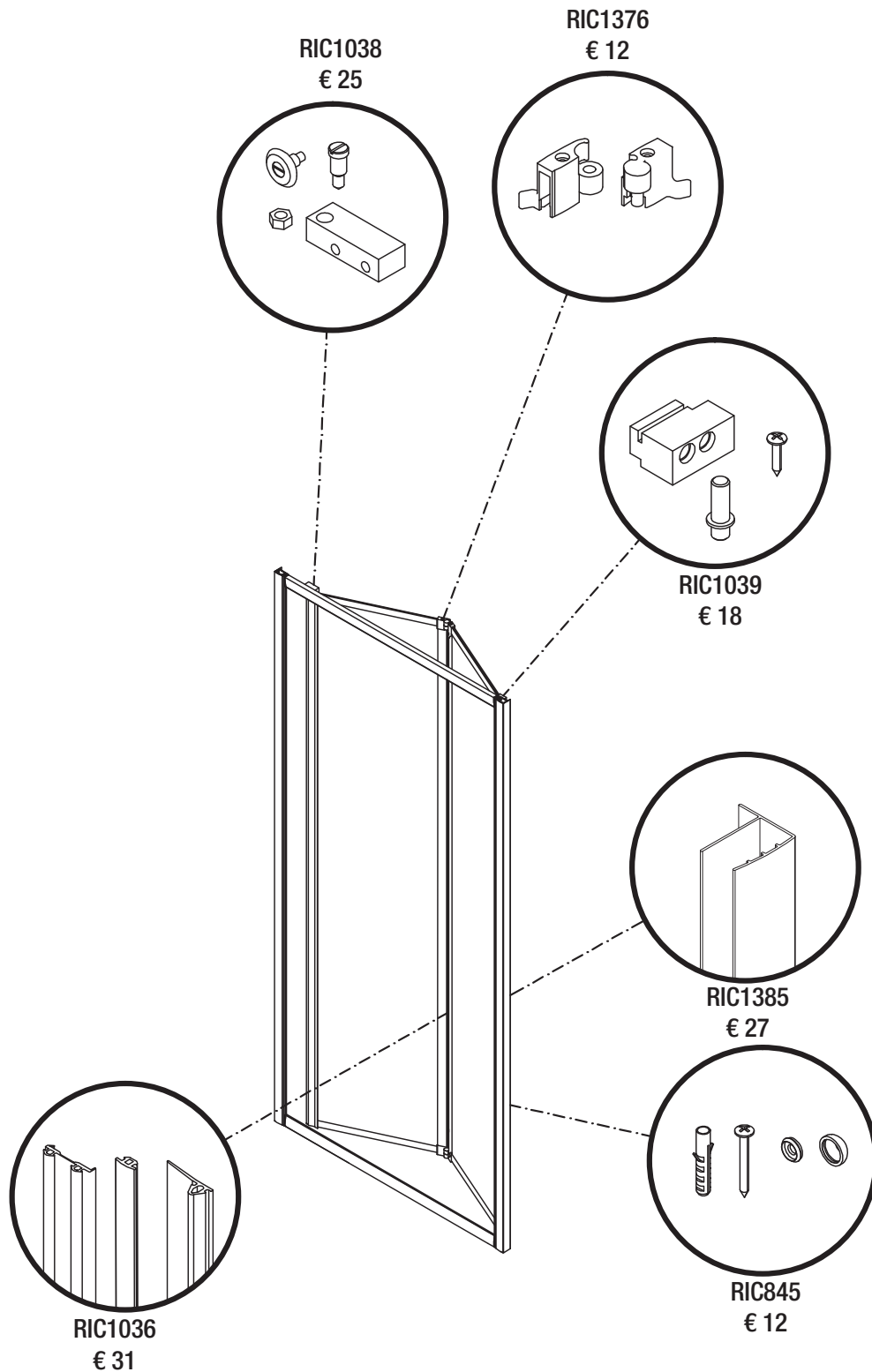

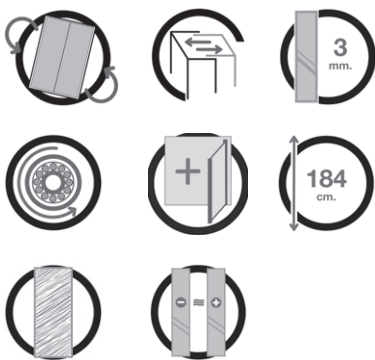

VST

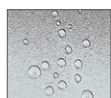

C

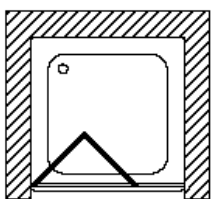

Porta a due ante a soffietto
Apertura con ante pieghevoli verso l'interno

Bifolding door
Inwards folding doors opening

Articolo Article	Estensibilità (cm) Extension	Finitura Pannelli Panels Finishing	Codice EAN EAN Code	L1 (€)
B-SI2110	68-71	VST	8019002079770	275
		C	8019002079732	255
B-SI2115	72-75	VST	8019002079787	285
		C	8019002079749	260
B-SI2120	76-79	VST	8019002079794	295
		C	8019002079756	265
B-SI2125	88-91	VST	8019002079800	310
		C	8019002079763	270

Prezzi IVA esclusa
Price VAT not included

Il modello si compone di n° colli di spedizione: 1
The model is composed of n° packings: 1

Prodotti speciali: NON DISPONIBILI
Special products: NOT AVAILABLE

OPERA

Porta a due ante a soffietto, apertura con ante pieghevoli verso l'interno

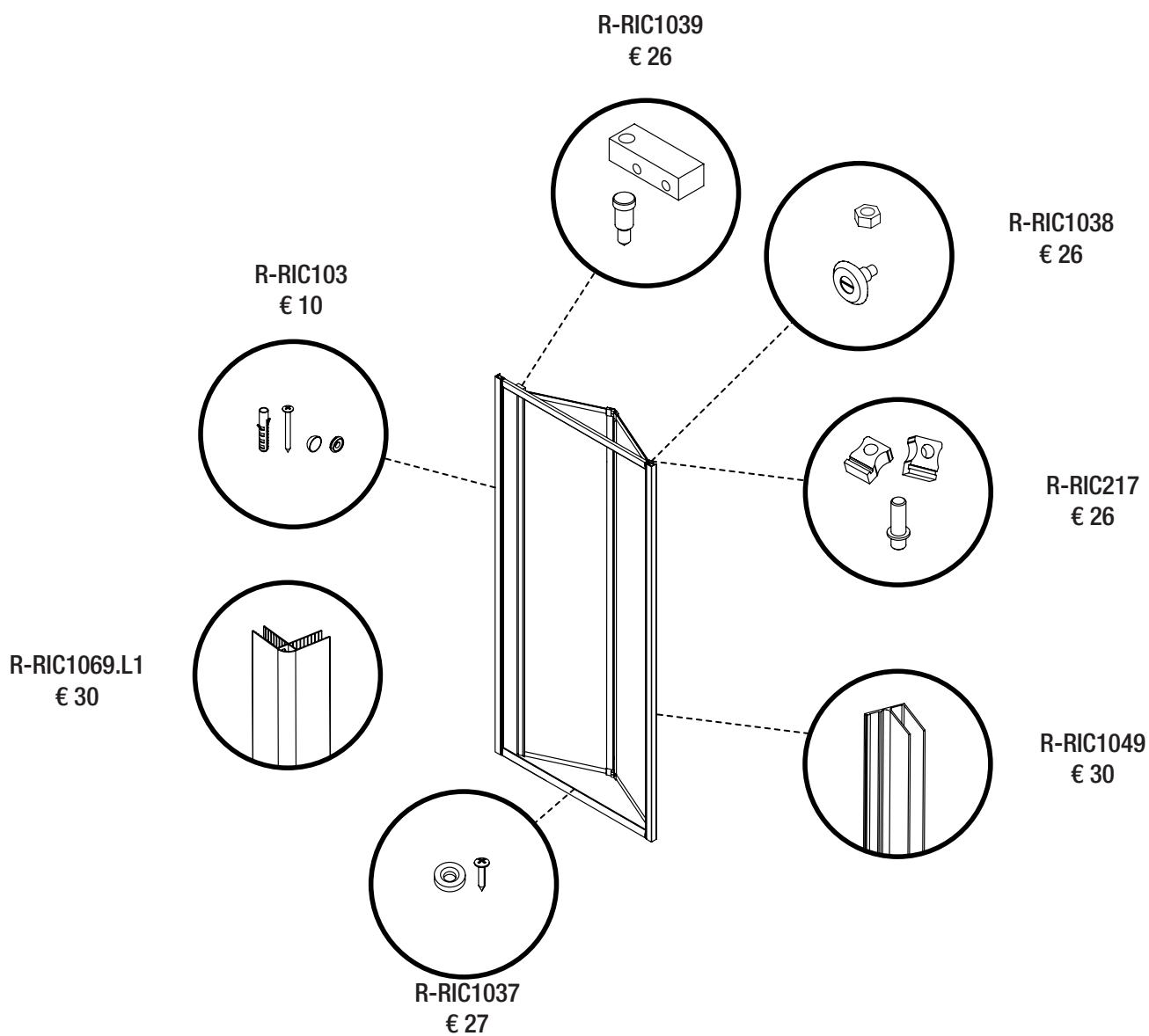

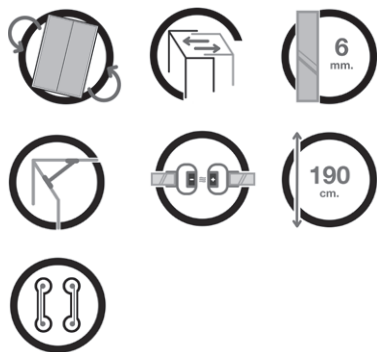

VTR

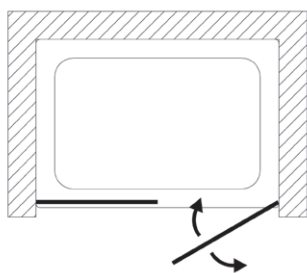

Porta ad un'anta a battente con fissa in linea
Apertura verso l'esterno

Single pivot door with in line fixed wall
Shower enclosure with outwards pivot door

Codici porta a battente

Articolo Article	Estensibilità (cm) Extension	Finitura Pannelli Panels Finishing	Codice EAN EAN Code	KL (€)
B-TE502	64-68	VTR	8019002094735	560
B-TE503	74-78	VTR	8019002094742	580
B-TE504	84-88	VTR	8019002094759	595

Codici parete fissa

B-TE527	32,5-36,5	VTR	8019002094827	295
B-TE528	42,5-46,5	VTR	8019002094834	305
B-TE529	52,5-56,5	VTR	8019002094841	315

Prezzi IVA esclusa
Price VAT not included

ATTENZIONE: per ottenere la composizione come da foto bisogna sommare il prezzo della porta battente con quello della parete fissa desiderata.
CAUTION: To obtain the composition as photos must add the price of the folding door with the fixed panel desired wall.

Il modello si compone di n° colli di spedizione: 1
The model is composed of n° packings: 1

Prodotti speciali: NON DISPONIBILI
Special products: NOT AVAILABLE

JAZZ

Porta ad un'anta a battente con fissa in linea, apertura verso l'esterno

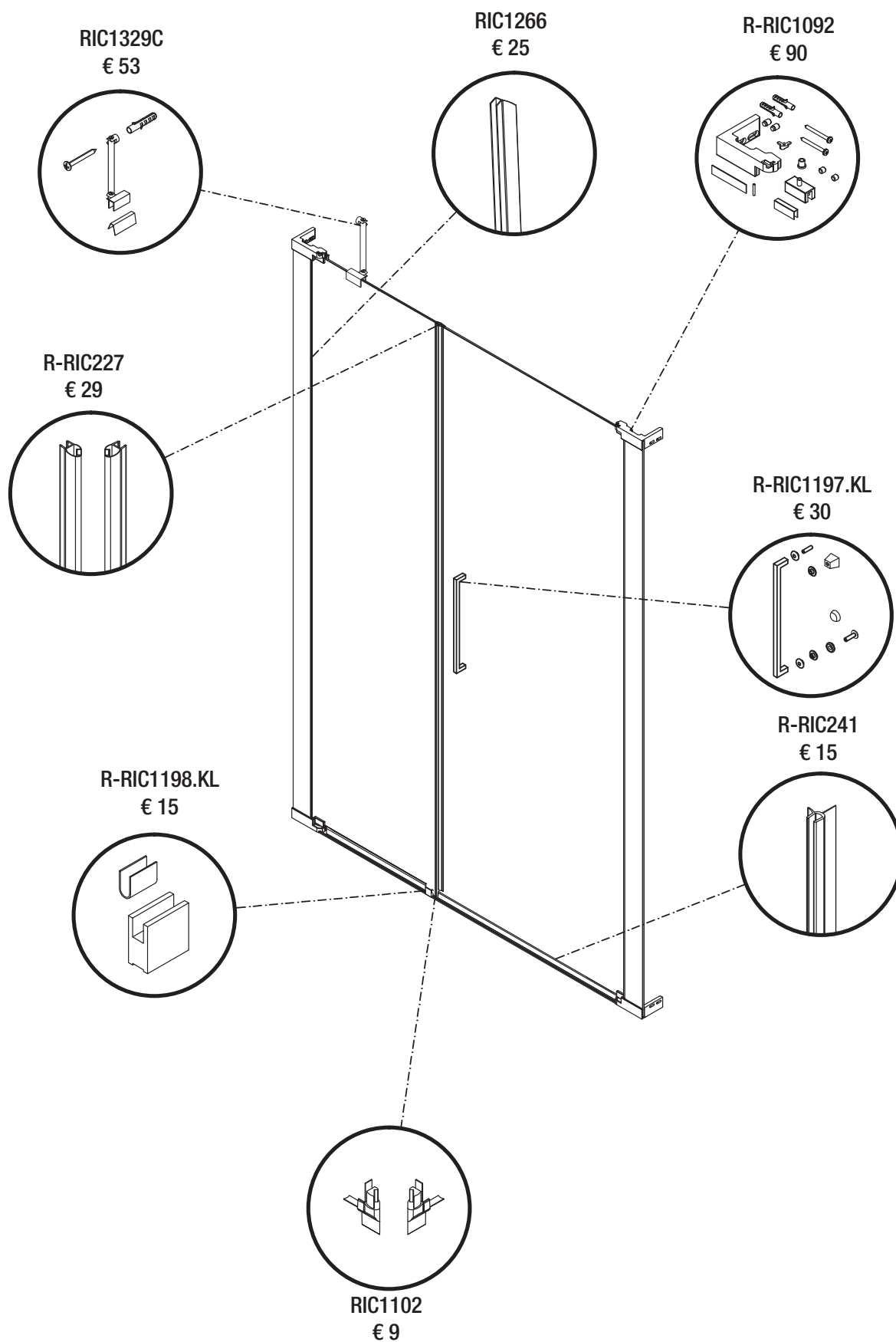

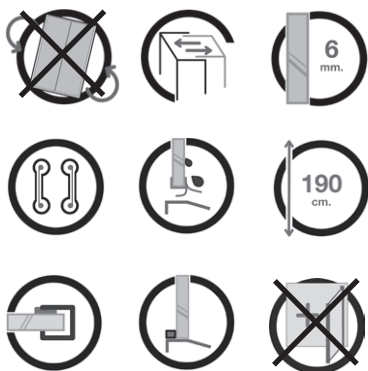

VTR

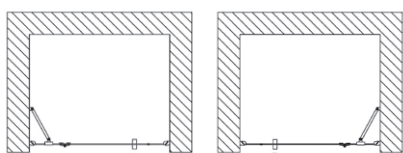

SX

DX



Porta ad un'anta a battente
Apertura verso l'esterno

Single pivot door
Shower enclosure with outward opening pivot door

Articolo Article	Estensibilità (cm) Extension	Finitura Pannelli Panels Finishing	Codice EAN EAN Code	L1 (€)	Codice EAN EAN Code	KL (€)
B-NP436/DX	86-90	VTR	8019002107527	500	8019002107503	600
B-NP436/SX			8019002107534	500	8019002107510	600
B-NP438/DX	94-98	VTR	8019002107565	510	8019002107541	615
B-NP438/SX			8019002107572	510	8019002107558	615
B-NP439/DX	98-102	VTR	8019002107602	515	8019002107589	620
B-NP439/SX			8019002107619	515	8019002107596	620
B-NP443/DX	114-118	VTR	8019002107640	535	8019002107626	645
B-NP443/SX			8019002107657	535	8019002107633	645
B-NP444/DX	118-122	VTR	8019002107688	540	8019002107664	650
B-NP444/SX			8019002107695	540	8019002107671	650

Abbinamento porta battente con parete fissa
Matching swing door with fixed panel

Prezzi IVA esclusa
Price VAT not included

Il modello si compone di n° colli di spedizione: 1
The model is composed of n° packings: 1



Prodotti speciali: Prezzo di listino + 40%
Special products: Price List + 40%

ARPA

Porta ad un'ante a battente, apertura verso l'esterno

PORTA BATTENTE

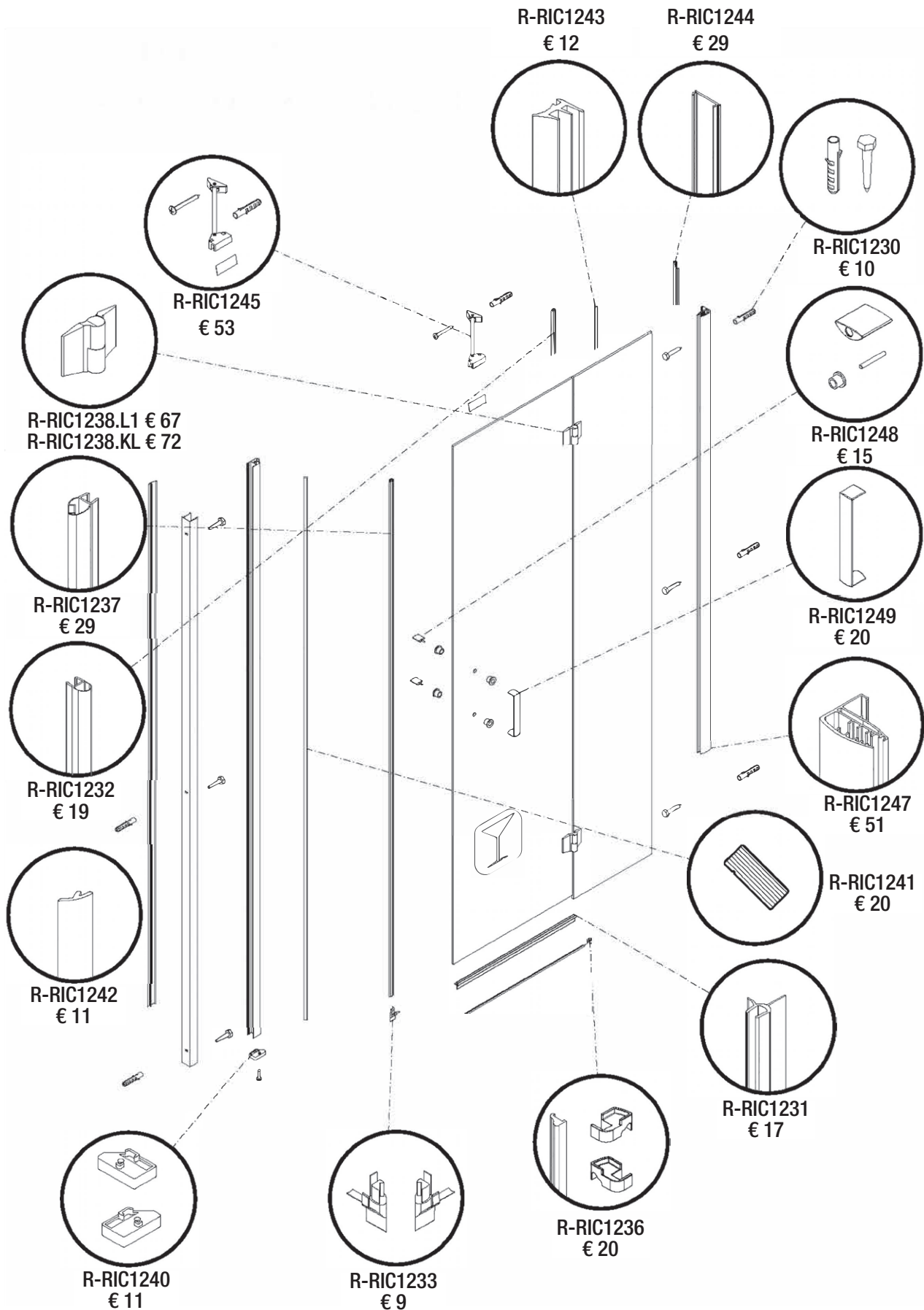

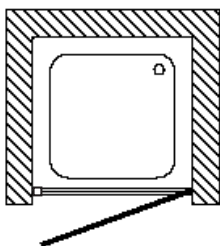

Porta ad un'anta a battente
Apertura verso l'esterno

Single pivot door
Shower enclosure with outward opening pivot door

Articolo Article	Estensibilità (cm) Extension	Finitura Pannelli Panels Finishing	Codice EAN EAN Code	L1 (€)	Codice EAN EAN Code	KL (€)
B-OC01	67-71	VTR	8019002104496	390	8019002104526	390
		VST	8019002104489	410	8019002104519	410
		VSQ	8019002104472	420	8019002104502	420
B-OC02	72-76	VTR	8019002104557	410	8019002104588	410
		VST	8019002104540	430	8019002104571	430
		VSQ	8019002104533	440	8019002104564	440
B-OC03	77-81	VTR	8019002104618	420	8019002104649	420
		VST	8019002104601	450	8019002104632	450
		VSQ	8019002104595	460	8019002104625	460
B-OC04	87-91	VTR	8019002104670	440	8019002104700	440
		VST	8019002104663	470	8019002104694	470
		VSQ	8019002104656	480	8019002104687	480

Prezzi IVA esclusa
Price VAT not included

Il modello si compone di n° colli di spedizione: 1
The model is composed of n° packings: 1



Prodotti speciali: Prezzo di listino + 40%
Special products: Price List + 40%

ORCHESTRA

Porta ad un'anta a battente, apertura verso l'esterno

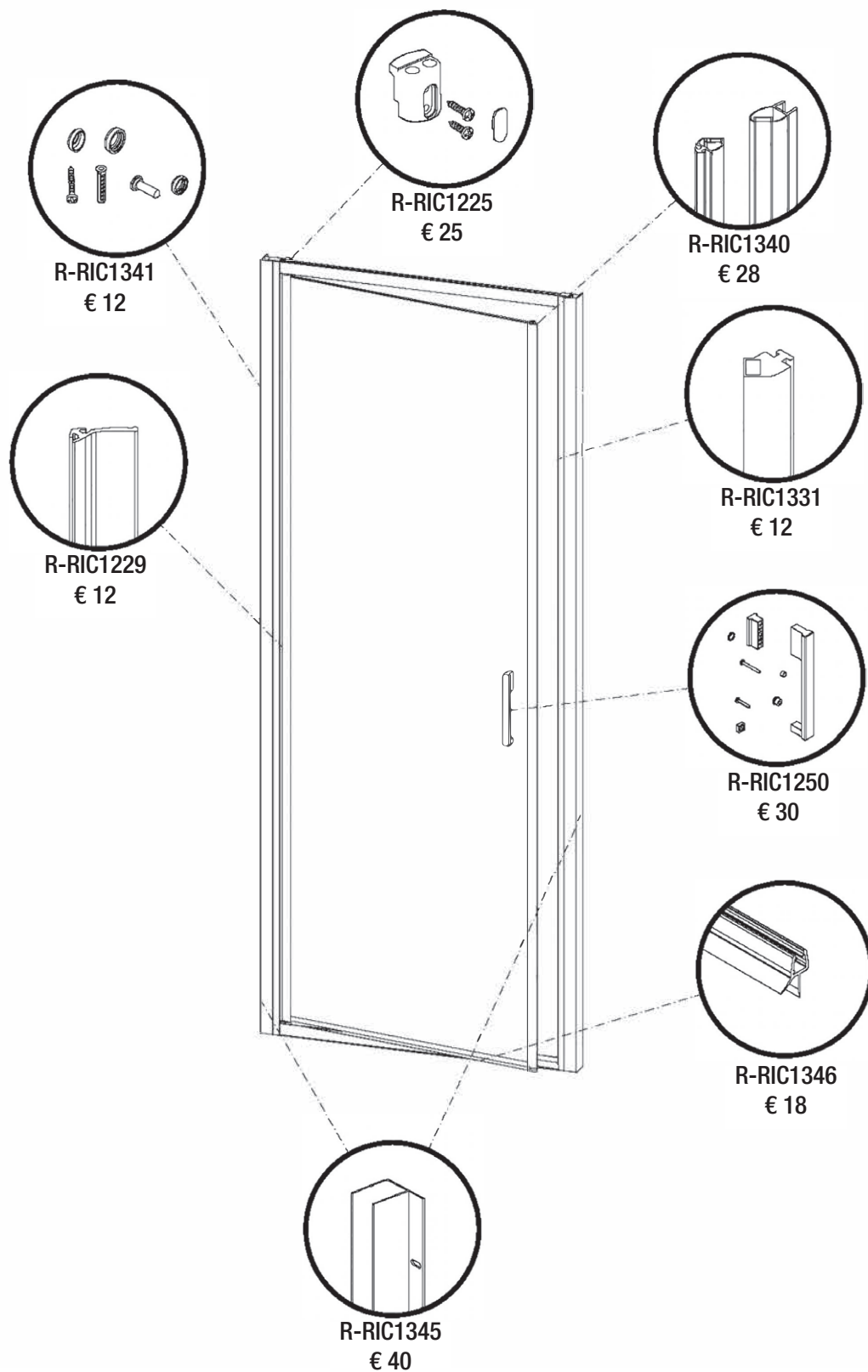

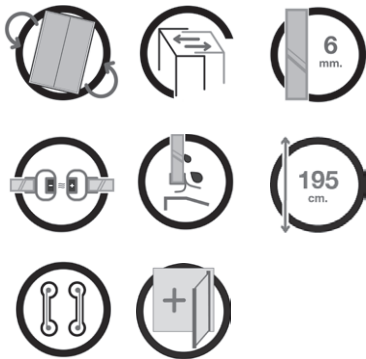

VTR

VST

VSQ

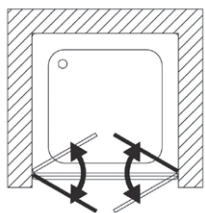

Porta a due ante a battente
Apertura verso l'interno e verso l'esterno

Double pivot door
Shower enclosure with outward and inward pivot doors

Articolo Article	Estensibilità (cm) Extension	Finitura Pannelli Panels Finishing	Codice EAN EAN Code	L1 (€)	Codice EAN EAN Code	KL (€)
B-OC30	72-76	VTR	8019002105561	375	8019002105592	435
		VST	8019002105554	405	8019002105585	465
		VSQ	8019002106803	420	8019002105578	480
B-OC32	77-81	VTR	8019002105622	385	8019002105653	440
		VST	8019002105615	410	8019002105646	470
		VSQ	8019002105608	430	8019002105639	490
B-OC33	87-91	VTR	8019002105684	390	8019002105714	450
		VST	8019002105677	420	8019002105707	480
		VSQ	8019002105660	440	8019002105691	500
B-OC34	97-101	VTR	8019002105745	400	8019002105776	460
		VST	8019002105738	430	8019002105769	490
		VSQ	8019002105721	450	8019002105752	510

Prezzi IVA esclusa
Price VAT not included

Il modello si compone di n° colli di spedizione: 1
The model is composed of n° packings: 1



Prodotti speciali: Prezzo di listino + 40%
Special products: Price List + 40%

ORCHESTRA

Porta a due ante a battente, apertura verso l'esterno

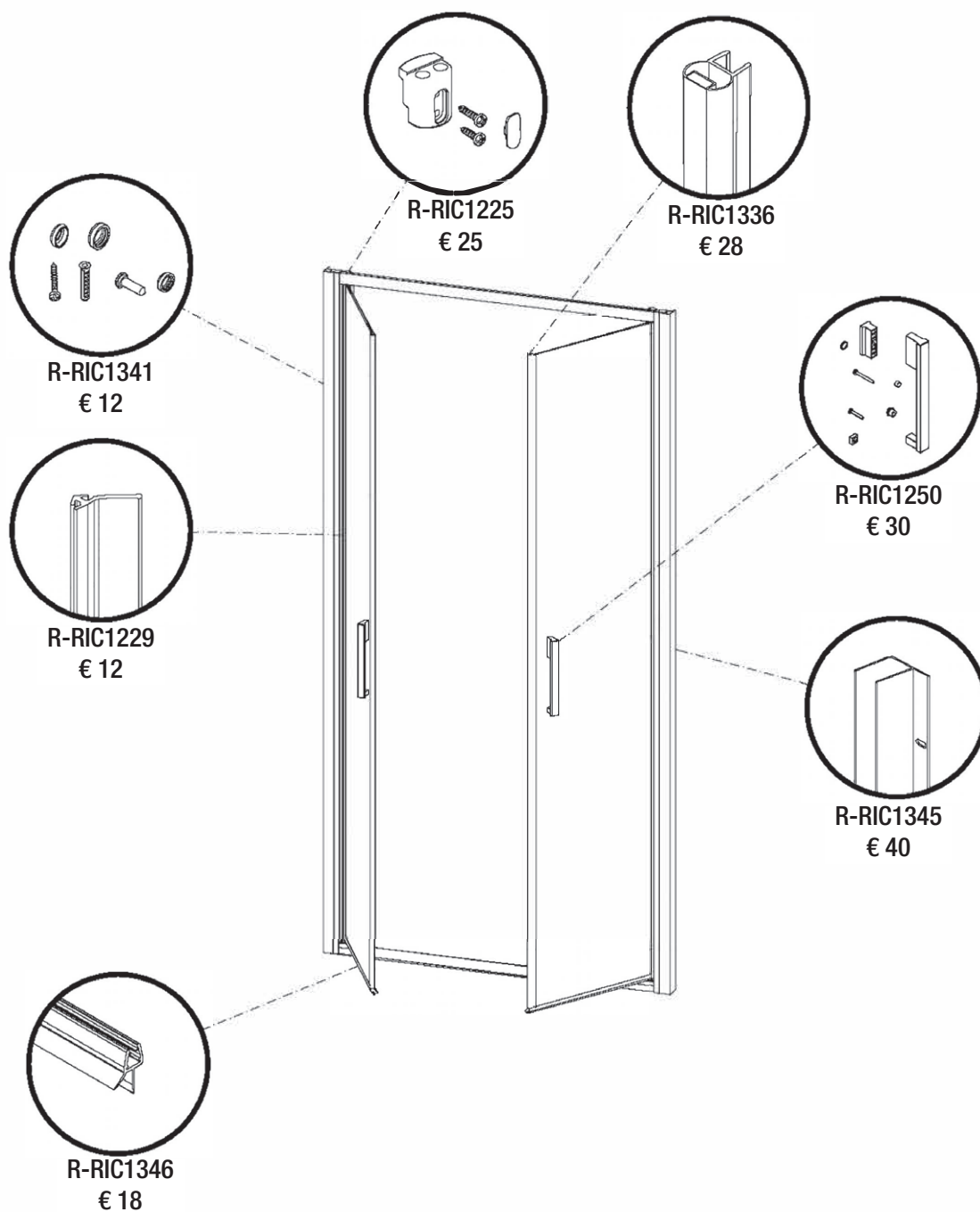

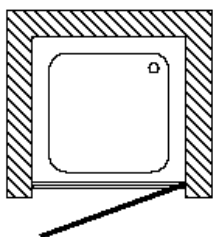
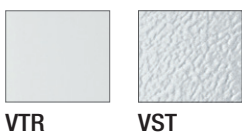
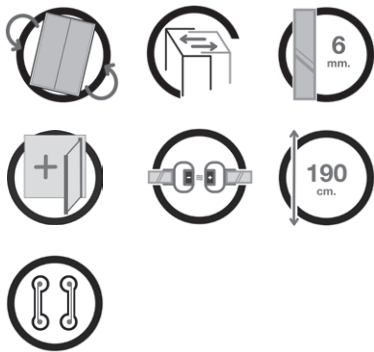

Porta ad un'anta a battente
Apertura verso l'esterno

Single pivot door
Shower enclosure with outwards pivot door

Articolo Article	Estensibilità (cm) Extension	Finitura Pannelli Panels Finishing	Codice EAN EAN Code	L1 (€)	Codice EAN EAN Code	KL (€)
B-EX835	68-71	VTR			8019002068392	360
		VST	8019002068422	325		
B-EX836	78-81	VTR			8019002068408	385
		VST	8019002068439	345		
B-EX837	88-91	VTR			8019002068415	405
		VST	8019002068446	360		

Prezzi IVA esclusa
Price VAT not included

MARACAS

Porta ad un'anta a battente, apertura verso l'esterno

R-RIC1060.L1
R-RIC1060.KL
€ 40

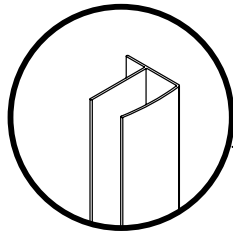

R-RIC1066
€ 12

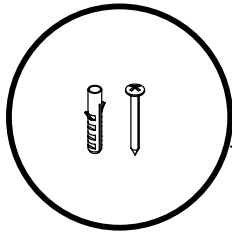

R-RIC1067
€ 30

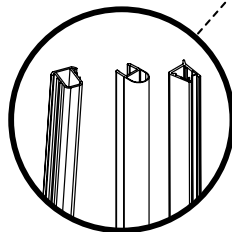
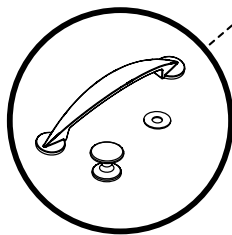

R-RIC1043
€ 15

R-RIC1097.L1
R-RIC1097.KL
€ 30

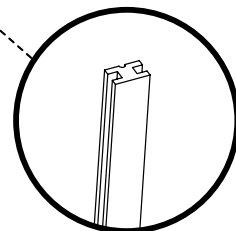
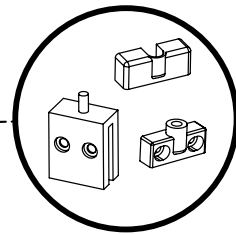

R-RIC1106
€ 20

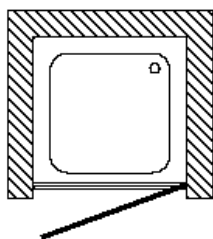
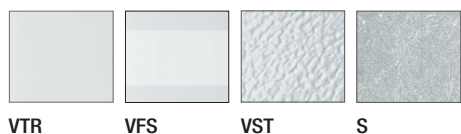
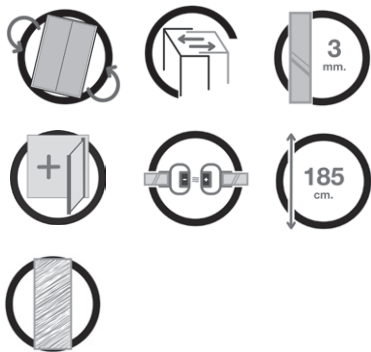

Porta ad un'anta a battente
Apertura verso l'esterno

Single pivot door
Shower enclosure with outwards pivot door

Articolo Article	Estensibilità (cm) Extension	Finitura Pannelli Panels Finishing	Codice EAN EAN Code	L1 (€)	Codice EAN EAN Code	KL (€)
B-PA642	69-73	VTR	8019002082930	265	8019002082947	320
		VST	8019002082954	285	8019002082961	335
		VFS	8019002084538	315	8019002084095	370
		S	8019002082916	255	8019002082923	305
B-PA644	77-81	VTR	8019002082992	280	8019002083005	330
		VST	8019002083012	300	8019002083029	355
		VFS	8019002084545	335	8019002084101	385
		S	8019002082978	270	8019002082985	320
B-PA646	85-89	VTR	8019002083050	295	8019002083067	355
		VST	8019002083074	315	8019002083081	370
		VFS	8019002084552	350	8019002084118	400
		S	8019002083036	285	8019002083043	340

Prezzi IVA esclusa
Price VAT not included

Il modello si compone di n° colli di spedizione: 1
The model is composed of n° packings: 1

Prodotti speciali: Prezzo di listino + 40%
Special products: Price List + 40%



TENORE

Porta ad un'anta a battente, apertura verso l'esterno

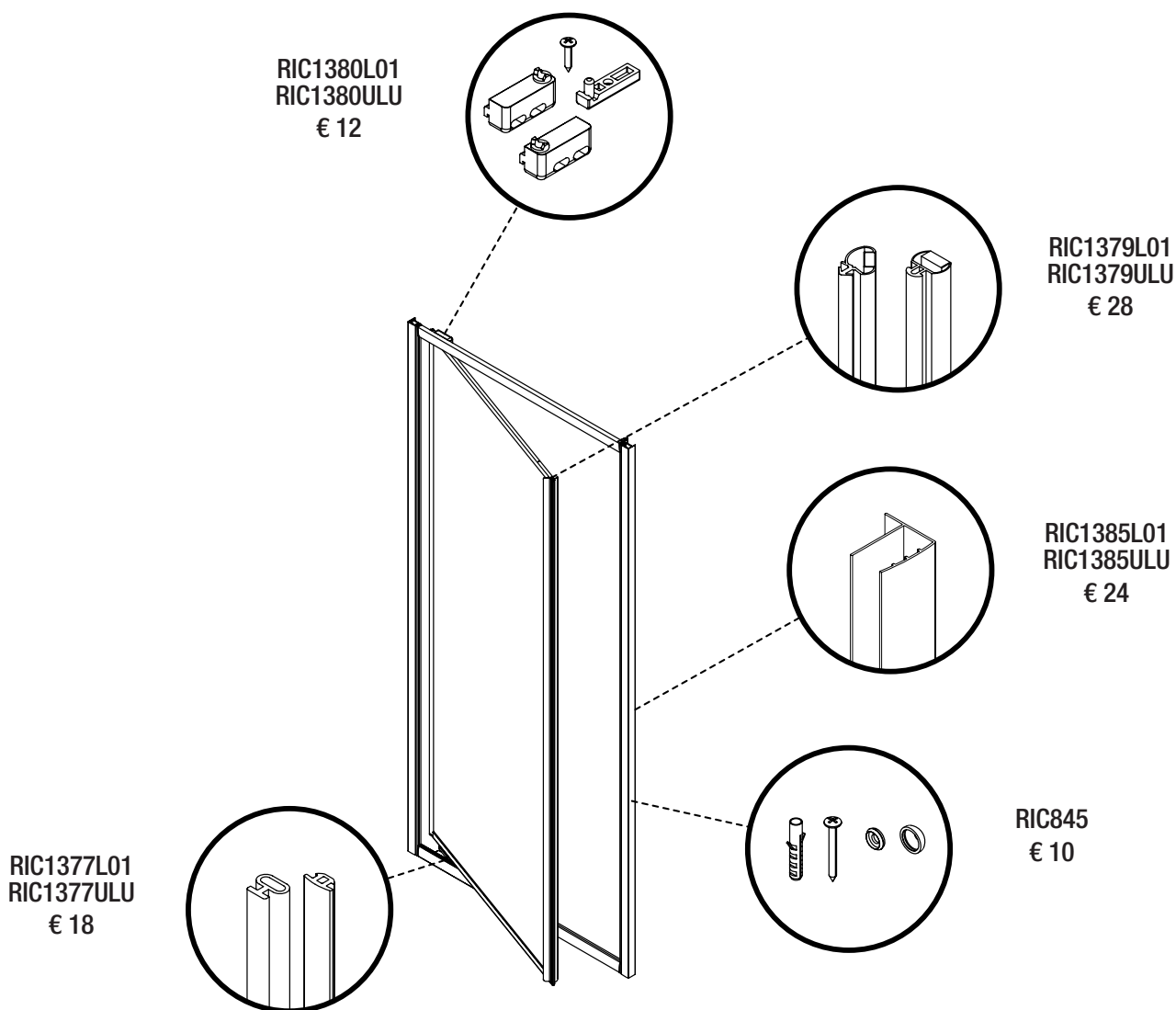

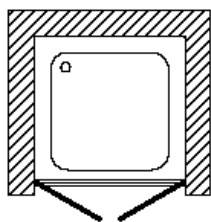
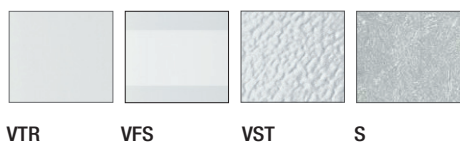
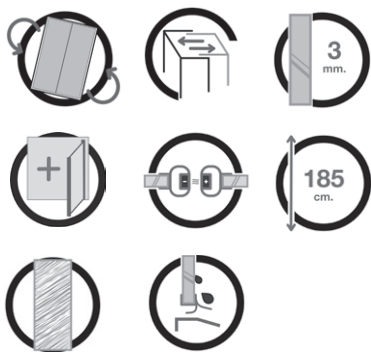

Porta a due ante a battente
Apertura verso l'esterno

Double pivot door
Shower enclosure with outward pivot doors

Articolo Article	Estensibilità (cm) Extension	Finitura Pannelli Panels Finishing	Codice EAN EAN Code	L1 (€)	Codice EAN EAN Code	KL (€)
B-PA652	69-73	VTR	8019002082688	305	8019002082695	380
		VST	8019002082701	325	8019002082718	400
		VFS	8019002084507	400	8019002084064	465
		S	8019002082664	275	8019002082671	335
B-PA654	77-81	VTR	8019002082749	325	8019002082756	400
		VST	8019002082763	350	8019002082770	420
		VFS	8019002084514	420	8019002084071	485
		S	8019002082725	295	8019002082732	355
B-PA656	85-89	VTR	8019002082800	350	8019002082817	420
		VST	8019002082824	370	8019002082831	445
		VFS	8019002084521	445	8019002084088	500
		S	8019002082787	315	8019002082794	380

Prezzi IVA esclusa
Price VAT not included

Il modello si compone di n° colli di spedizione: 1
The model is composed of n° packings: 1



Prodotti speciali: Prezzo di listino + 40%
Special products: Price List + 40%

TENORE

Porta a due ante a battente, apertura verso l'esterno

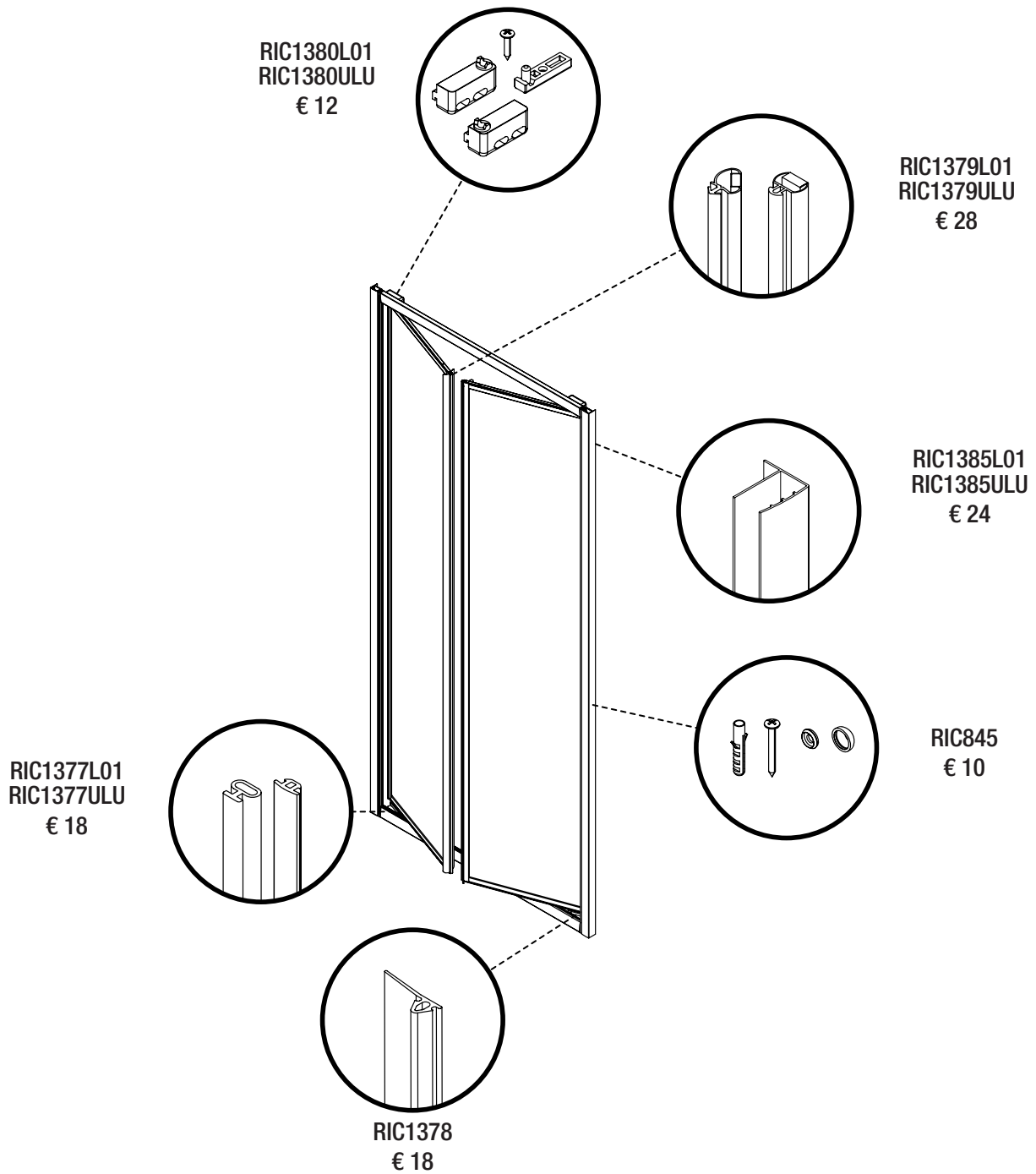

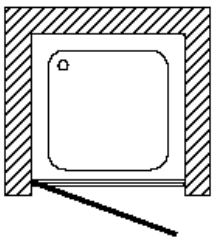
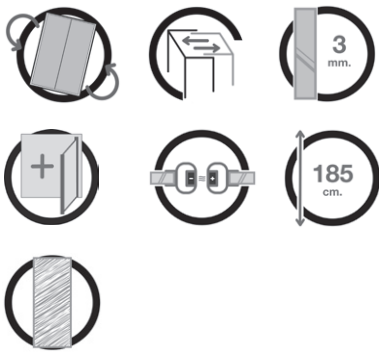

Porta ad un'anta a battente
Apertura verso l'esterno

Single pivot door
Shower enclosure with outwards pivot door

Articolo Article	Estensibilità (cm) Extension	Finitura Pannelli Panels Finishing	Codice EAN EAN Code	L1 (€)
B-GC541	65-69	VTR	8019002048080	245
		VST	8019002048097	250
		C	8019002048073	235
B-GC542	69-73	VTR	8019002048110	245
		VST	8019002048127	255
		C	8019002048103	235
B-GC543	73-77	VTR	8019002048141	250
		VST	8019002048158	255
		C	8019002048134	240
B-GC544	77-81	VTR	8019002048172	255
		VST	8019002048189	260
		C	8019002048165	245

Prezzi IVA esclusa
Price VAT not included

Il modello si compone di n° colli di spedizione: 1
The model is composed of n° packings: 1



Prodotti speciali: Prezzo di listino + 40%
Special products: Price List + 40%

FIATI

Porta ad un'anta a battente, apertura verso l'esterno

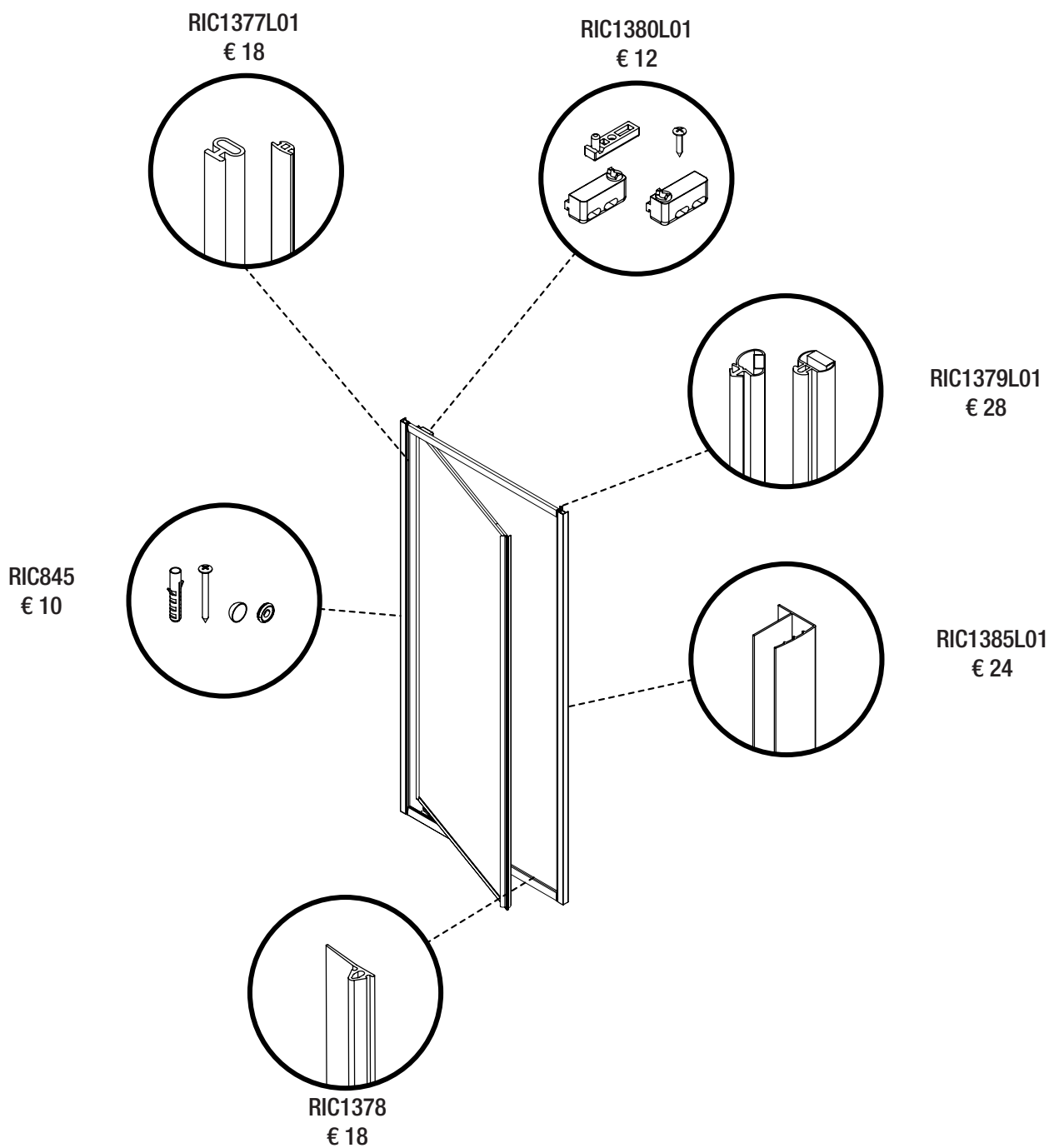

OPERA

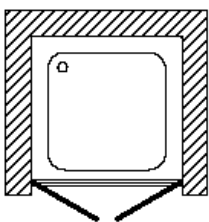
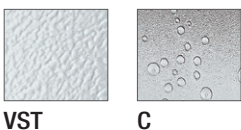
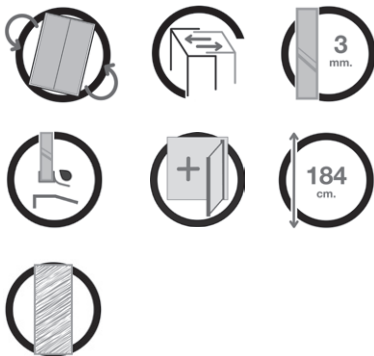

Porta a due ante a battente
Apertura verso l'esterno

Double pivot door
Shower enclosure with outward pivot doors

Articolo Article	Estensibilità (cm) Extension	Finitura Pannelli Panels Finishing	Codice EAN EAN Code	L1 (€)
B-SI2010	69-72	VST	8019002079954	230
		C	8019002079916	205
B-SI2015	73-76	VST	8019002079961	250
		C	8019002079923	215
B-SI2020	77-80	VST	8019002079978	255
		C	8019002079930	225
B-SI2025	89-92	VST	8019002079985	265
		C	8019002079947	225

Prezzi IVA esclusa
Price VAT not included

Il modello si compone di n° colli di spedizione: 1
The model is composed of n° packings: 1

Prodotti speciali: NON DISPONIBILI
Special products: NOT AVAILABLE

OPERA

Porta a due ante a battente, apertura verso l'esterno

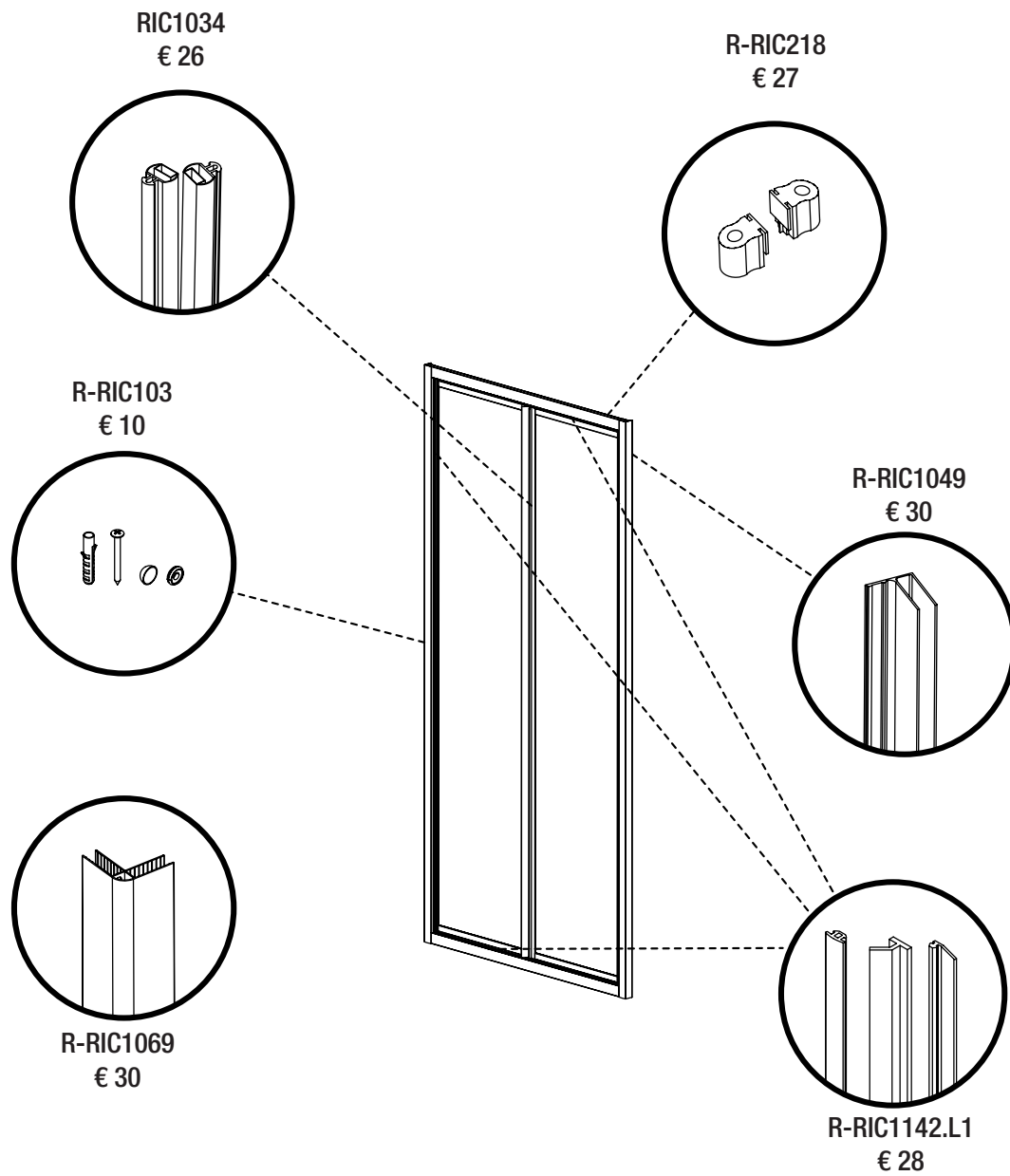

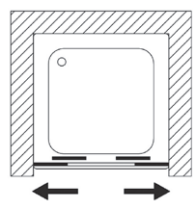
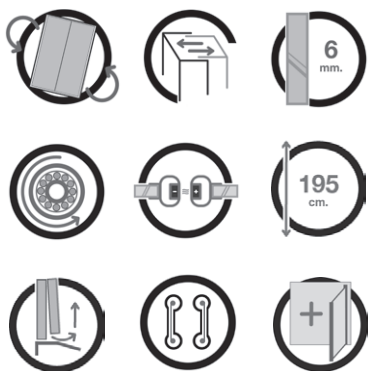

Porta scorrevole a quattro ante
Apertura centrale ad anta scorrevole,
due fisse e due apribili

Four panels door
Central opening with sliding panel;
two fixed and two can be opened

Articolo Article	Estensibilità (cm) Extension	Finitura Pannelli Panels Finishing	Codice EAN EAN Code	L1 (€)	Codice EAN EAN Code	KL (€)
B-0C44	137-141	VTR	8019002105844	445	8019002105943	510
		VST	8019002105813	490	8019002105929	530
		VSQ	8019002105783	510	8019002105905	550
B-0C46	157-161	VTR	8019002106025	485	8019002106124	530
		VST	8019002105998	530	8019002106100	550
		VSQ	8019002105967	550	8019002106087	570
B-0C47	167-171	VTR	8019002106209	510	8019002106308	550
		VST	8019002106179	550	8019002106285	570
		VSQ	8019002106148	570	8019002106261	590
B-0C48	177-181	VTR	8019002106384	540	8019002106483	570
		VST	8019002106353	570	8019002106469	590
		VSQ	8019002106322	590	8019002106445	610

Prezzi IVA esclusa
Price VAT not included

Il modello si compone di n° colli di spedizione: 1
The model is composed of n° packings: 1



Prodotti speciali: Prezzo di listino + 40%
Special products: Price List + 40%

ORCHESTRA

Porta scorrevole a quattro ante, due fisse e due apribili

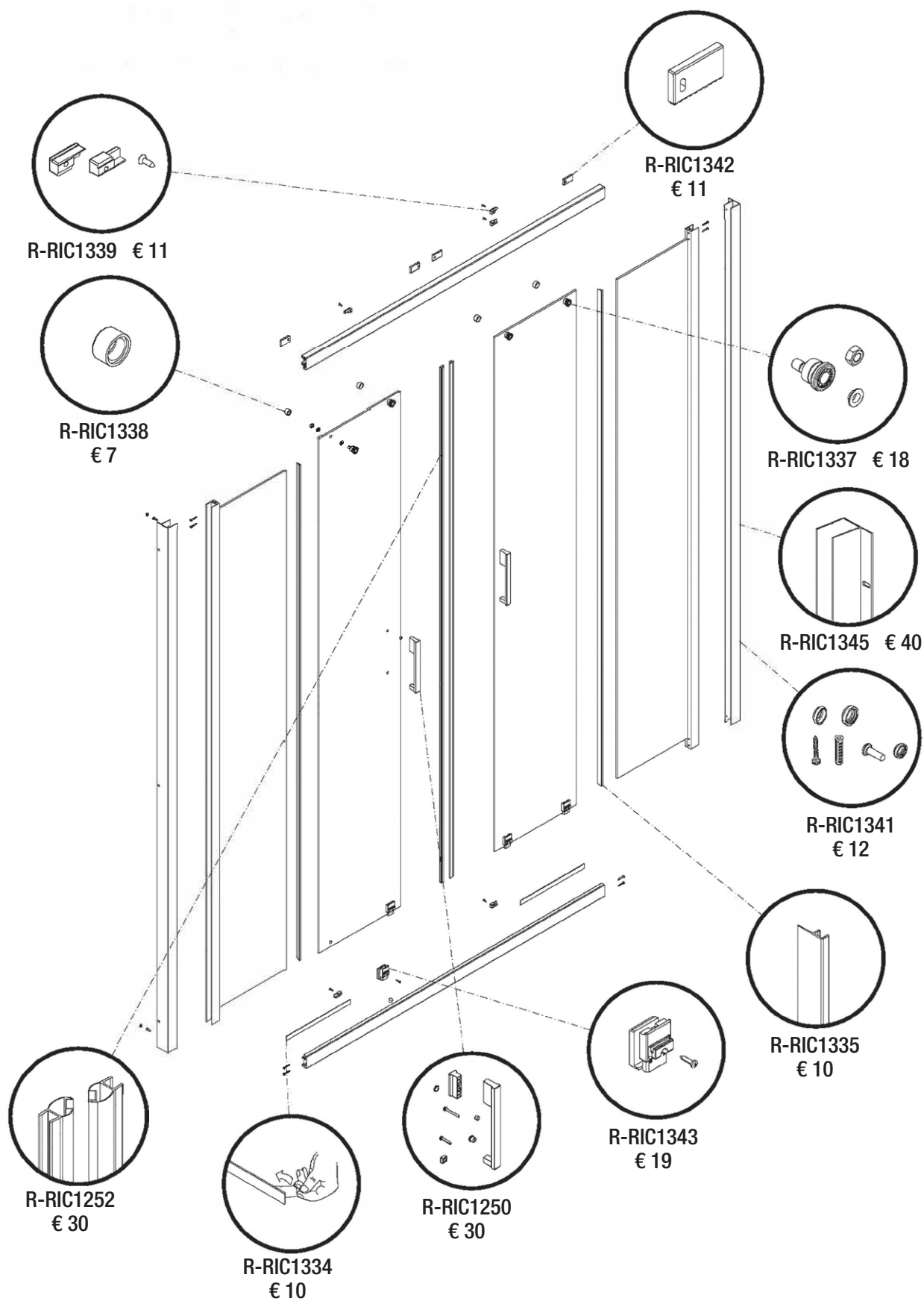

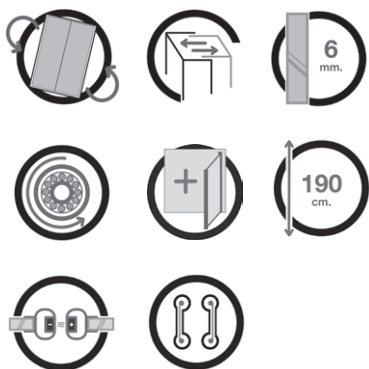

VTR

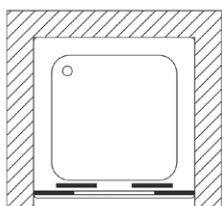

Porta scorrevole a quattro ante
Apertura centrale ad anta scorrevole,
due fisse e due apribili

Four panels door
Central opening with sliding panel;
two fixed and two can be opened

Articolo Article	Estensibilità (cm) Extension	Finitura Pannelli Panels Finishing	Codice EAN EAN Code	KL (€)
B-EX890	137-141	VTR	8019002098214	450
B-EX893	167-171	VTR	8019002098221	470
B-EX894	177-181	VTR	8019002098238	490

Prezzi IVA esclusa
Price VAT not included

MARACAS

Porta scorrevole a quattro ante, apertura laterale ad ante scorrevoli, due fisse e due apribili.

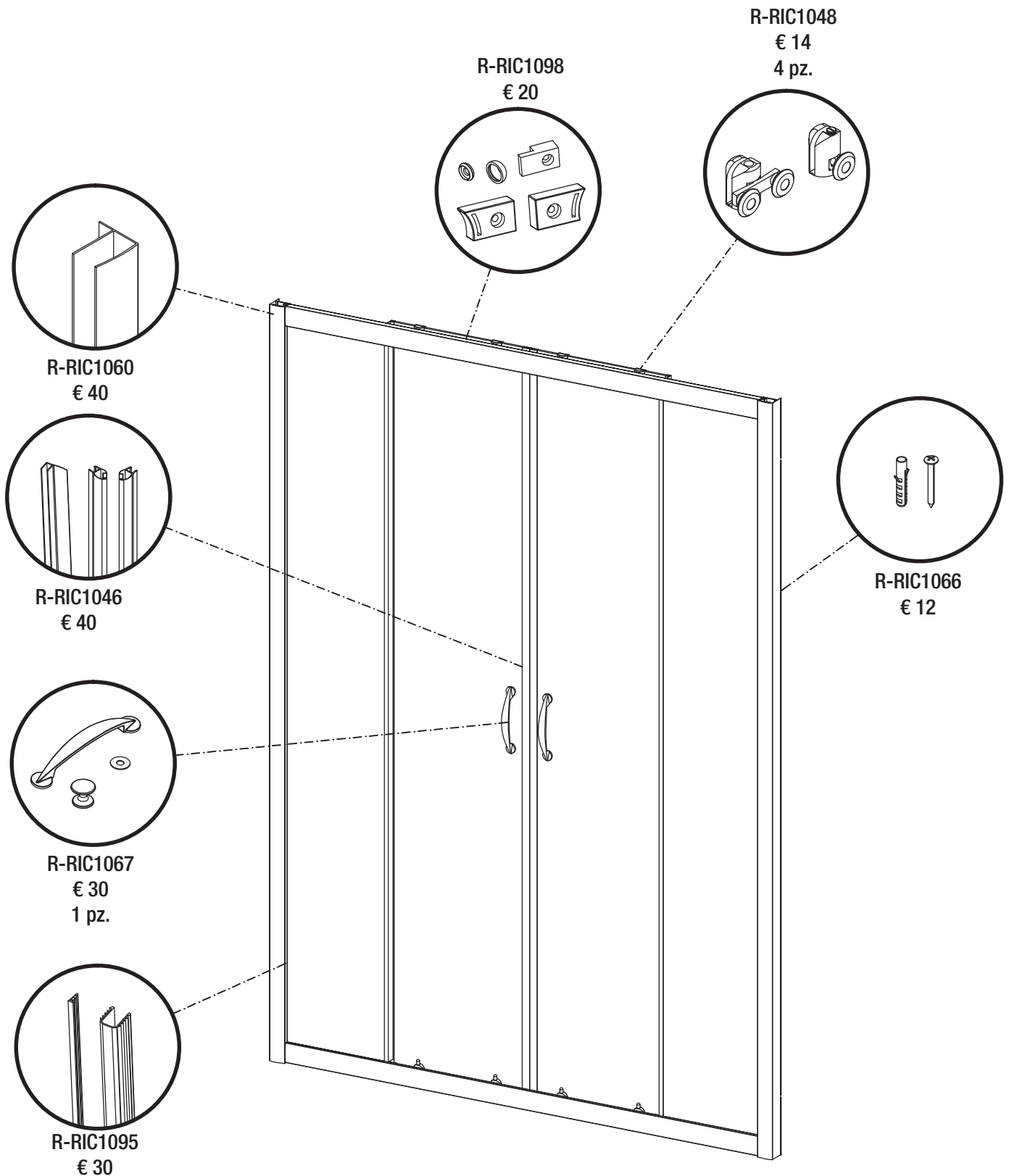

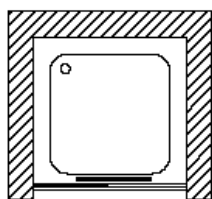

Porta scorrevole a due ante
Apertura laterale ad anta scorrevole,
una fissa ed una apribile

Two panels door
Lateral opening with sliding panel;
one fixed and one can be opened

Articolo Article	Estensibilità (cm) Extension	Finitura Pannelli Panels Finishing	Codice EAN EAN Code	L1 (€)	Codice EAN EAN Code	KL (€)
B-OC80	97-101	VTR	8019002104793	385	8019002104823	400
		VTS	8019002104786	405	8019002104816	425
		VSQ	8019002104779	430	8019002104809	450
B-OC83	117-121	VTR	8019002104854	430	8019002104885	450
		VTS	8019002104847	455	8019002104878	475
		VSQ	8019002104830	480	8019002104861	500
B-OC86	137-141	VTR	8019002104915	480	8019002104946	500
		VTS	8019002104908	500	8019002104939	520
		VSQ	8019002104892	525	8019002104922	545

Prezzi IVA esclusa
Price VAT not included

Il modello si compone di n° colli di spedizione: 1
The model is composed of n° packings: 1



Prodotti speciali: Prezzo di listino + 40%
Special products: Price List + 40%

ORCHESTRA

Porta scorrevole a due ante, una fissa e una apribile

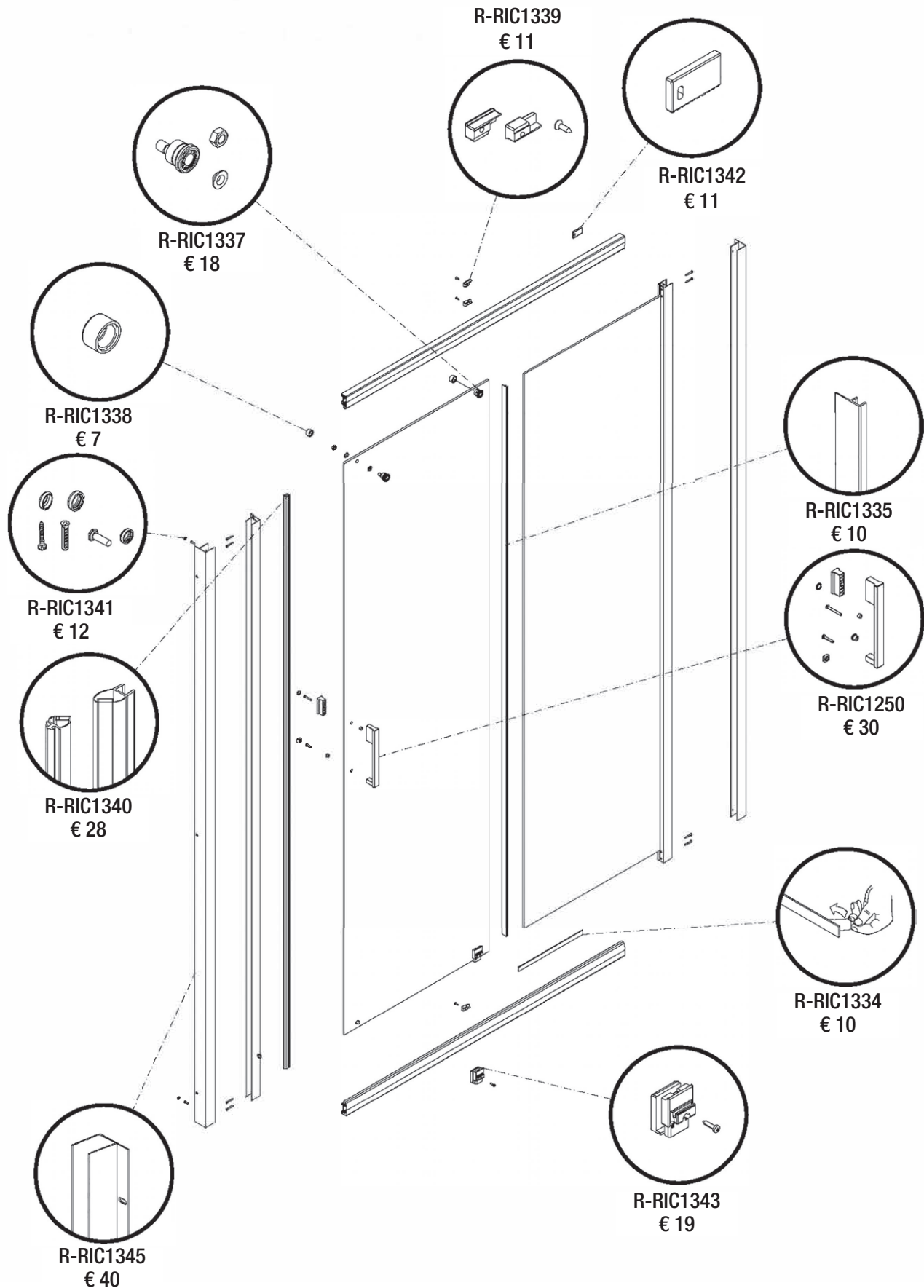

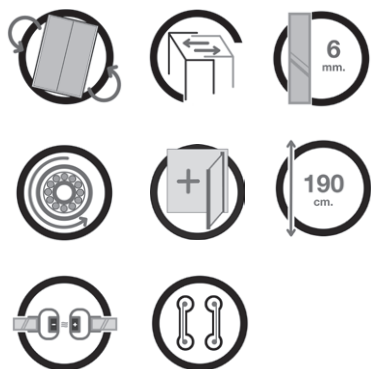

VTR

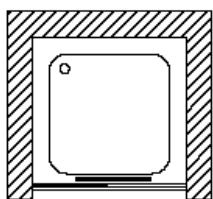

Porta scorrevole a due ante
Apertura laterale ad anta scorrevole,
una fissa ed una apribile

Two panels door
Lateral opening with sliding panel;
one fixed and one can be opened

Articolo Article	Estensibilità (cm) Extension	Finitura Pannelli Panels Finishing	Codice EAN EAN Code	KL (€)
B-EX840	96-100	VTR	8019002077844	380
B-EX841	116-120	VTR	8019002076717	430
B-EX843	132-136	VTR	8019002087508	450
B-EX844	136-140	VTR	8019002076120	470
B-EX845	157-161	VTR	8019002087515	490

Prezzi IVA esclusa
Price VAT not included

MARACAS

Porta scorrevole a due ante, una fissa e una apribile

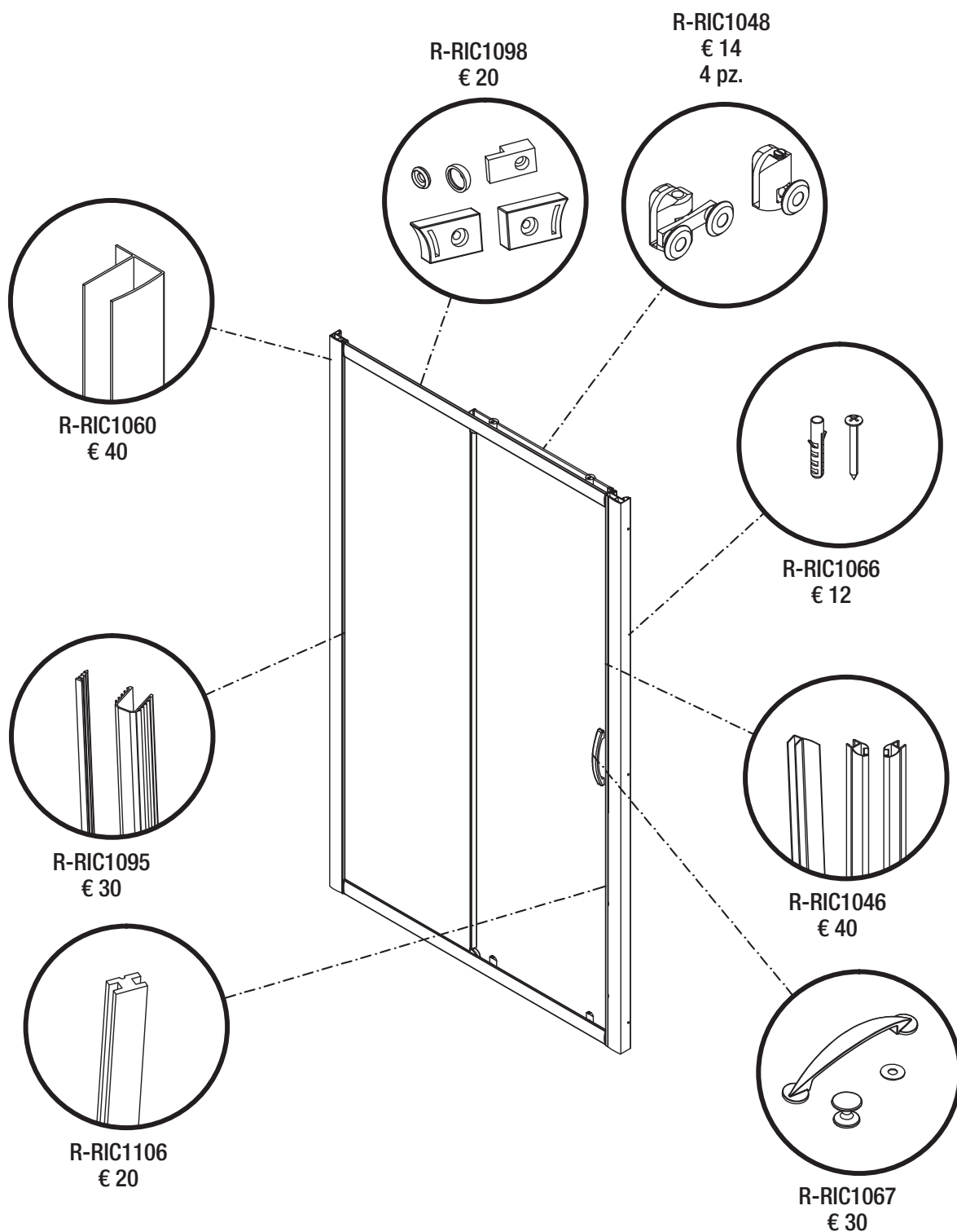

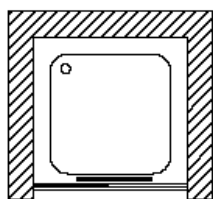
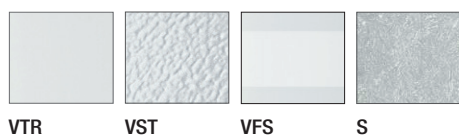

Porta scorrevole a due ante
Apertura laterale ad anta scorrevole,
una fissa ed una apribile

Two panels door
Lateral opening with sliding panel;
one fixed and one can be opened

Articolo Article	Estensibilità (cm) Extension	Finitura Pannelli Panels Finishing	Codice EAN EAN Code	L1 (€)	Codice EAN EAN Code	KL (€)
B-PA634	97-101	VTR	8019002083395	295	8019002083401	370
		VST	8019002083418	325	8019002083425	400
		VFS	8019002084606	410	8019002084224	475
		S	8019002083371	265	8019002083388	325
B-PA637	107-111	VTR	8019002083456	315	8019002083463	390
		VST	8019002083470	350	8019002083487	420
		VFS	8019002084163	435	8019002084231	495
		S	8019002083432	290	8019002083449	350
B-PA639	117-121	VTR	8019002083517	335	8019002083524	410
		VST	8019002083531	370	8019002083548	445
		VFS	8019002084620	455	8019002084248	515
		S	8019002083494	305	8019002083500	370

Prezzi IVA esclusa
Price VAT not included

Il modello si compone di n° colli di spedizione: 1
The model is composed of n° packings: 1



Prodotti speciali: Prezzo di listino + 40%
Special products: Price List + 40%

TENORE

Porta scorrevole a due ante, una fissa e una apribile

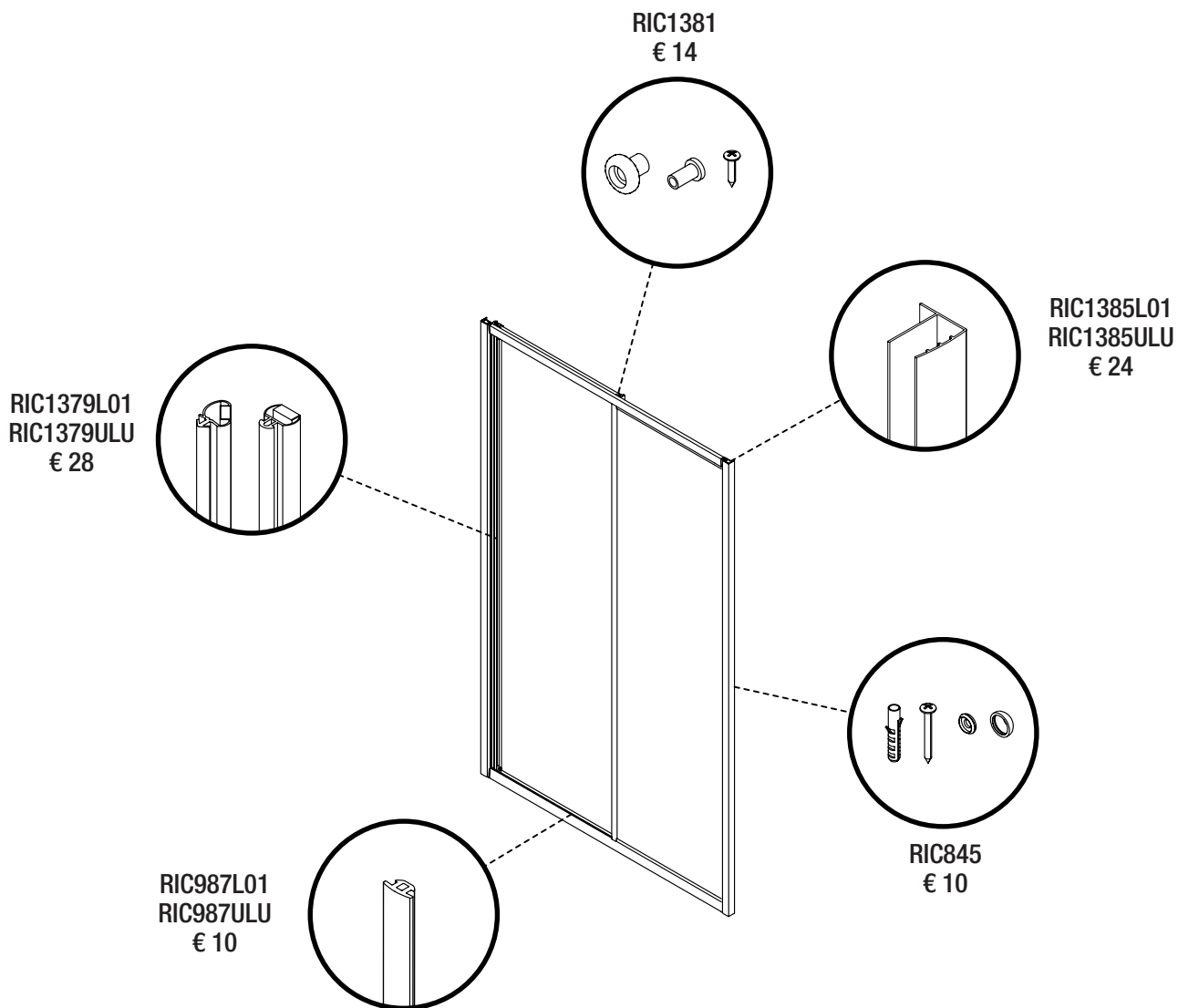

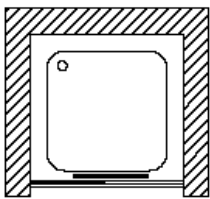
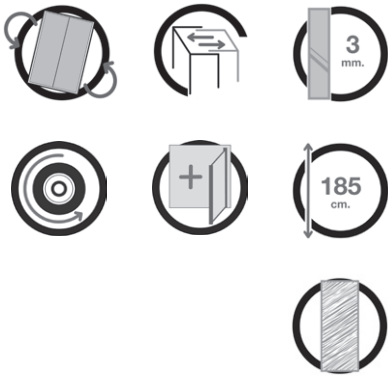

Porta scorrevole a due ante
Apertura laterale ad anta scorrevole,
una fissa ed una apribile

Two panels door
Lateral opening with sliding panel;
one fixed and one can be opened

Articolo Article	Estensibilità (cm) Extension	Finitura Pannelli Panels Finishing	Codice EAN EAN Code	L1 (€)
B-GC534	97-101	VTR	8019002085313	285
		VST	8019002085320	295
		C	8019002085306	265
B-GC536	102-106	VTR	8019002085344	305
		VST	8019002085351	315
		C	8019002085337	285
B-GC537	107-111	VTR	8019002085375	330
		VST	8019002085382	340
		C	8019002085368	305
B-GC538	112-116	VTR	8019002085405	350
		VST	8019002085412	360
		C	8019002085399	325
B-GC539	117-122	VTR	8019002085436	370
		VST	8019002085443	380
		C	8019002085429	350

Prezzi IVA esclusa
Price VAT not included

Il modello si compone di n° colli di spedizione: 1
The model is composed of n° packings: 1



Prodotti speciali: Prezzo di listino + 40%
Special products: Price List + 40%

FIATI

Porta scorrevole a due ante, una fissa e una apribile

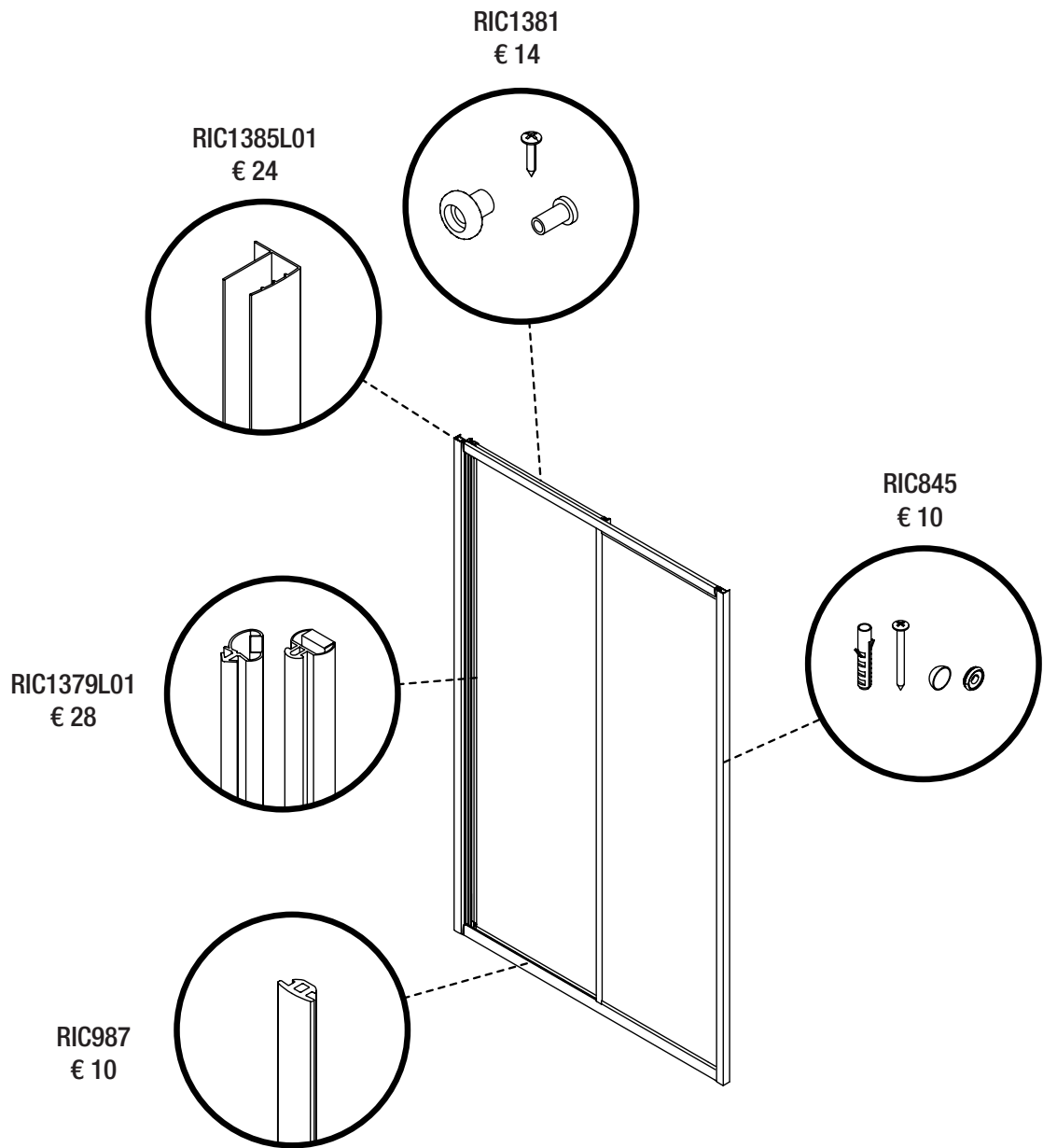

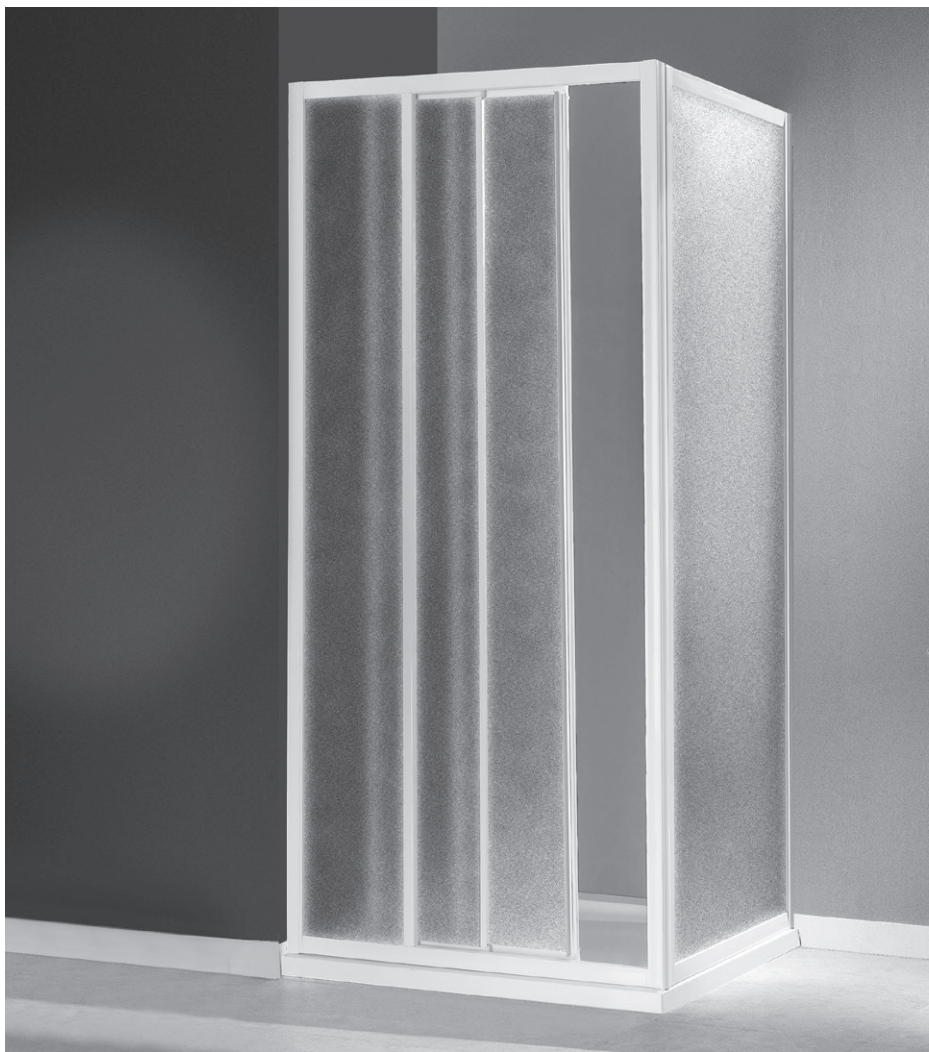
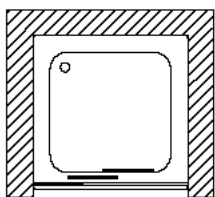
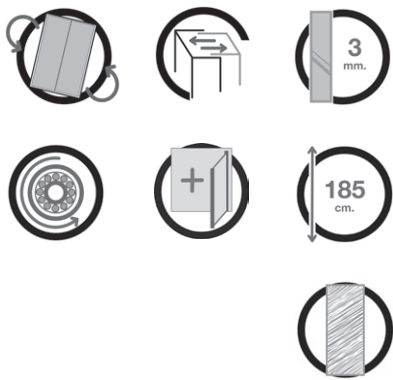

Porta scorrevole a tre ante
Apertura laterale ad ante scorrevoli,
una fissa e due apribili

Three panels door
Lateral opening with sliding doors,
one fixed and two can be opened

Articolo Article	Estensibilità (cm) Extension	Finitura Pannelli Panels Finishing	Codice EAN EAN Code	L1 (€)
B-GC401	67-71	VTR	8019002085122	265
		VST	8019002085139	275
		C	8019002085146	235
B-GC402	77-81	VTR	8019002085153	285
		VST	8019002085160	295
		C	8019002085177	255
B-GC403	85-89	VTR	8019002085184	305
		VST	8019002085191	315
		C	8019002085207	275
B-GC404	97-101	VTR	8019002085214	325
		VST	8019002085221	335
		C	8019002085238	295
B-GC405	107-111	VTR	8019002085245	350
		VST	8019002085252	360
		C	8019002085269	315
B-GC406	117-121	VTR	8019002085276	370
		VST	8019002085283	380
		C	8019002085290	340

Il modello si compone di n° colli di spedizione: 1
The model is composed of n° packings: 1



Prodotti speciali: Prezzo di listino + 40%
Special products: Price List + 40%

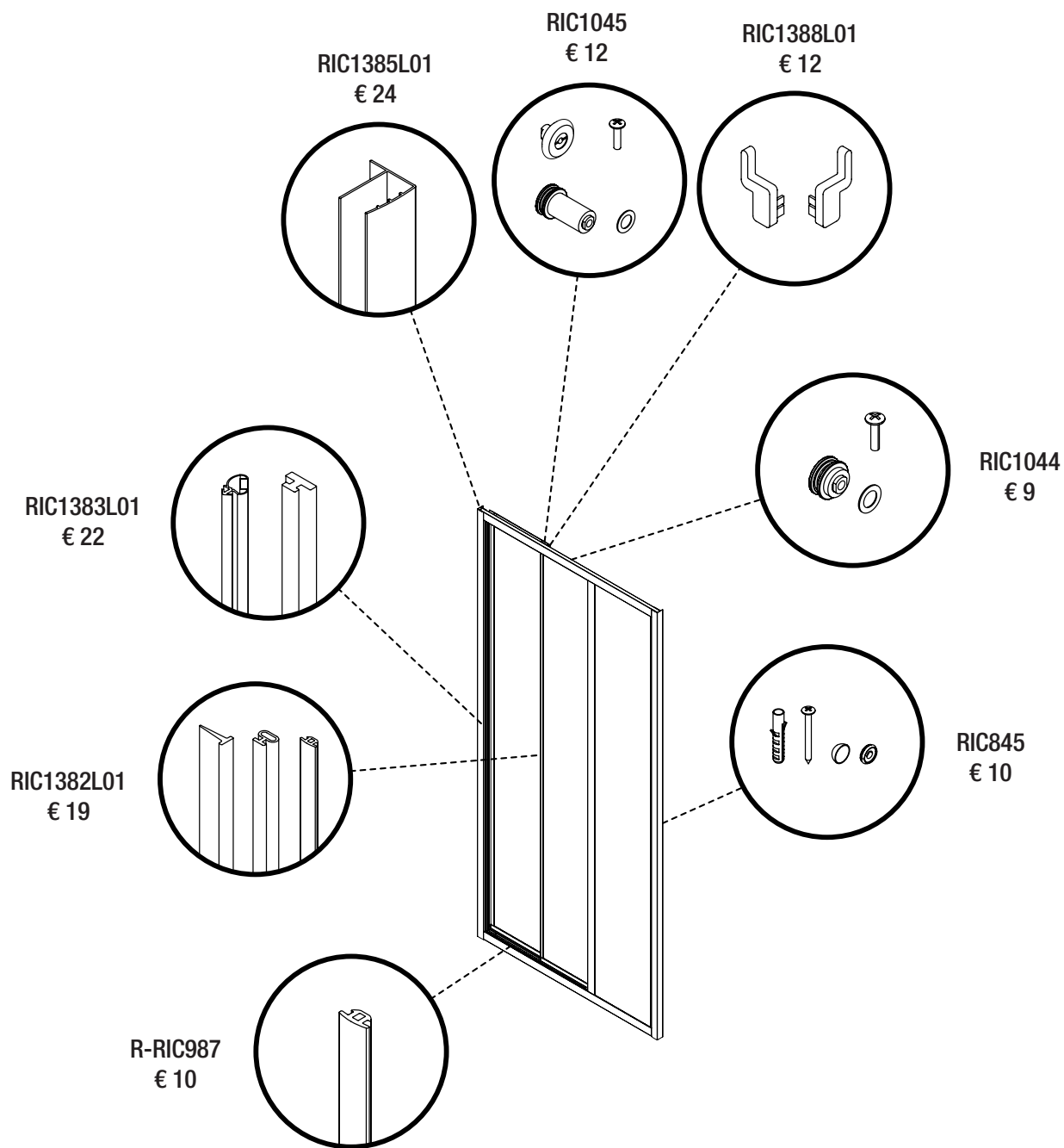

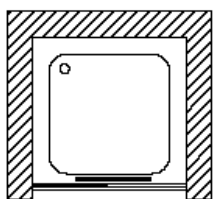
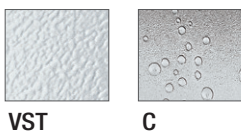
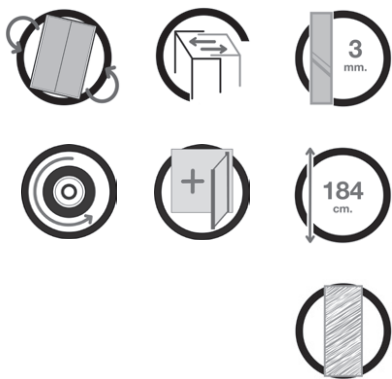

Porta scorrevole a due ante
Apertura laterale ad anta scorrevole,
una fissa ed una apribile

Two panels door
Lateral opening with sliding panel;
one fixed and one can be opened

Articolo Article	Estensibilità (cm) Extension	Finitura Pannelli Panels Finishing	Codice EAN EAN Code	L1 (€)
B-SI2500	92-95	VST	8019002079862	210
		C	8019002079817	170
B-SI2501	98-101	VST	8019002079879	220
		C	8019002079824	170
B-SI2502	104-107	VST	8019002079886	230
		C	8019002079831	175
B-SI2503	110-113	VST	8019002079893	235
		C	8019002079848	180
B-SI2504	116-119	VST	8019002079909	250
		C	8019002079855	185

Prezzi IVA esclusa
Price VAT not included

OPERA

Porta scorrevole a due ante, una fissa e una apribile

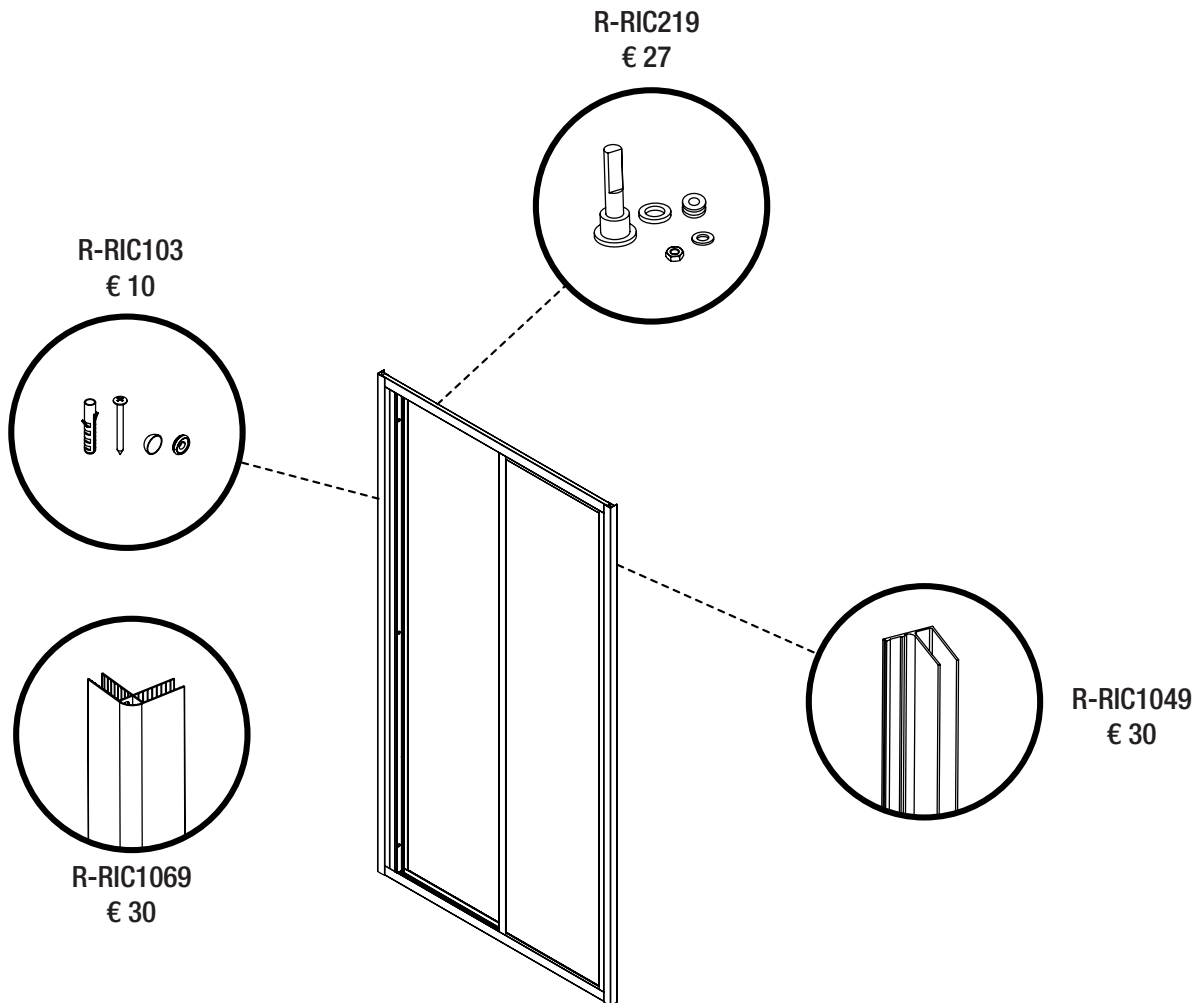

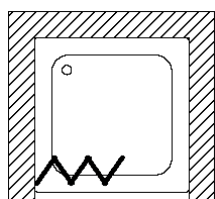

Porta PVC riducibile
Apertura ad ante pieghevoli

Door PVC reducible
Opening with folding panels

Articolo Article	Estensibilità (cm) Extension	Finitura Pannelli Panels Finishing	Codice EAN EAN Code	L1 (€)
B-PV109	60-70	PVC	8019002074386	160
B-PV110	70-80	PVC	8019002053992	165
B-PV111	80-90	PVC	8019002054005	175
B-PV112	90-100	PVC	8019002054012	180
B-PV113	110-120	PVC	8019002054029	195
B-PV114	120-130	PVC	8019002054036	215
B-PV115	140-150	PVC	8019002054043	250

Non abbinabile a parete fissa
Not to match with fixed panel

Prezzi IVA esclusa
Price VAT not included

Questo prodotto è riducibile alla misura desiderata, basta tagliare il binario ed eliminare le stecche fino ad ottenere la misura desiderata.
This product can be reduced to the desired size, simply cut the track and eliminate the sticks until you get the desired size.

Il modello si compone di n° colli di spedizione: 1
The model is composed of n° packings: 1

Prodotti speciali: NON DISPONIBILI
Special products: NOT AVAILABLE

SIPARIO

Porta riducibile in PVC, apertura ad anta ripieghevole

PORTE SCORREVOLI

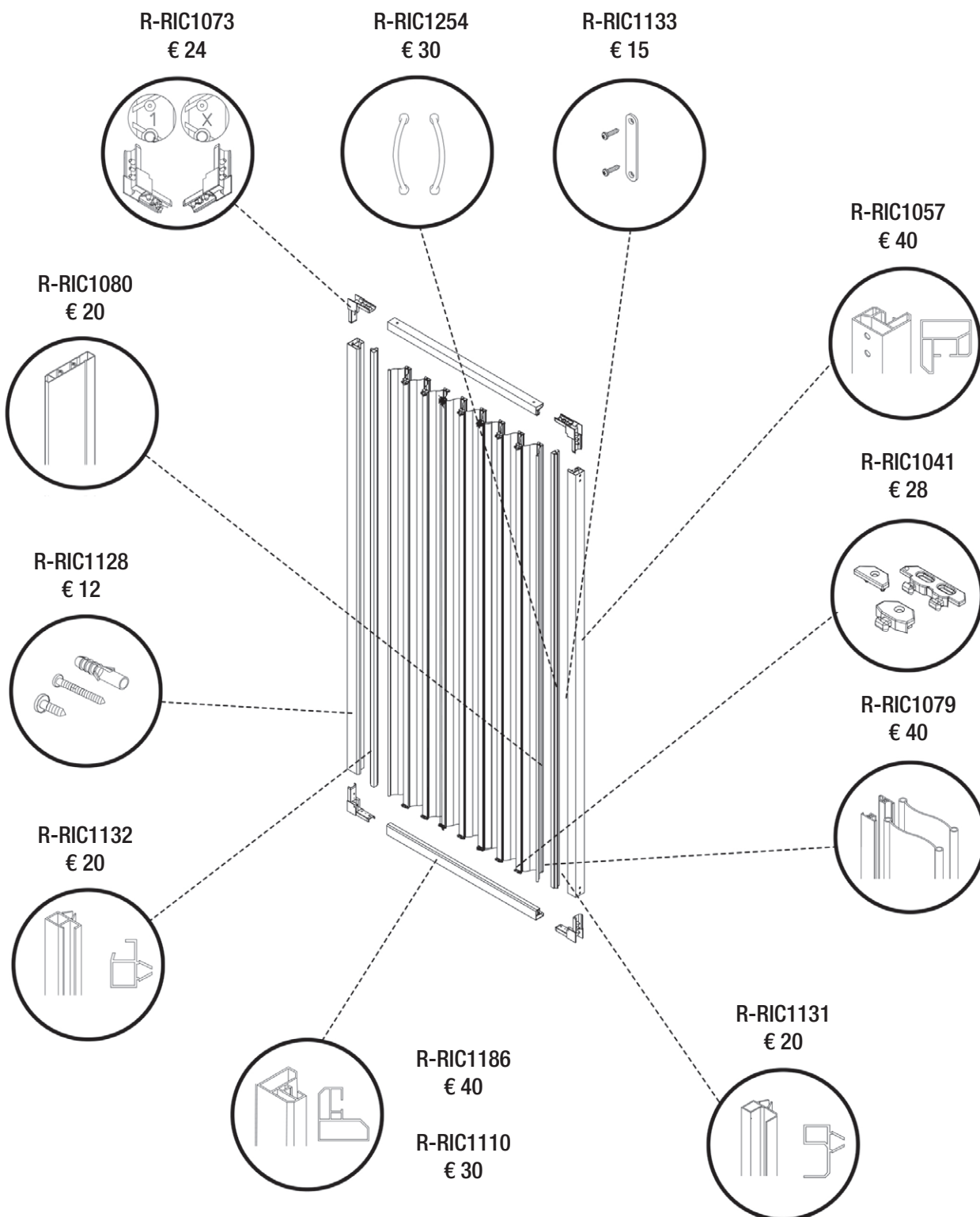



VTR

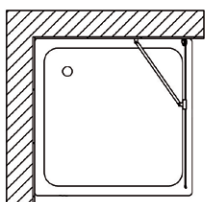

Parete fissa
E' possibile formare cabine doccia a 2 lati

Fixed panel
to form 2 sides shower enclosures

Articolo Article	Estensibilità (cm) Extension	Finitura Pannelli Panels Finishing	Codice EAN EAN Code	KL (€)
B-TE531	64-68	VTR	8019002094766	370
B-TE532	74-78	VTR	8019002094773	390
B-TE533	84-88	VTR	8019002094780	390

Prezzi IVA esclusa
Price VAT not included

JAZZ

Parete fissa per abbinamenti

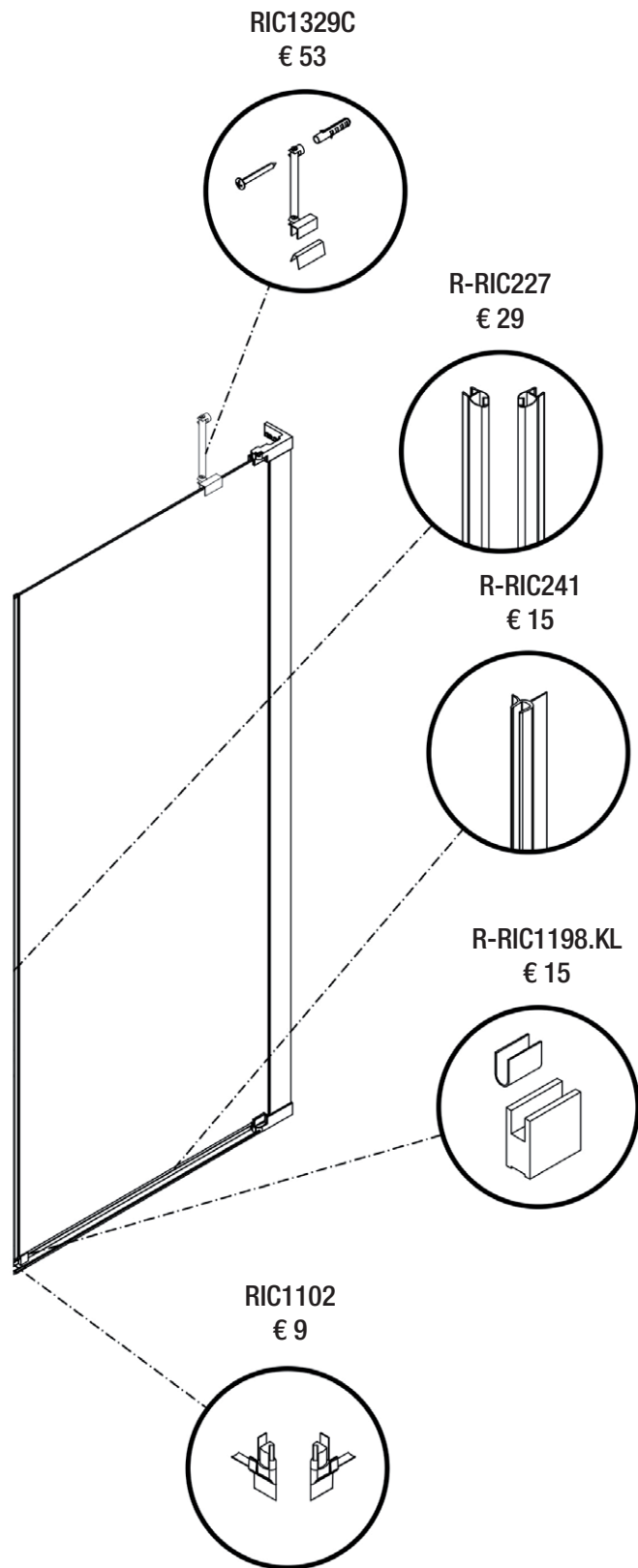

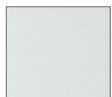
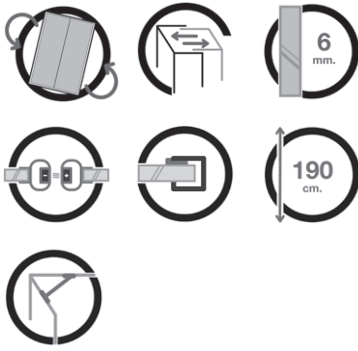

VTR

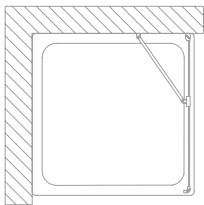

Parete fissa per abbinamenti
Non è possibile formare cabine doccia a 3 lati

Fixed panel for combination
It's impossible to form 3 sides shower enclosures

Articolo Article	Estensibilità (cm) Extension	Finitura Pannelli Panels Finishing	Codice EAN EAN Code	L1 (€)	Codice EAN EAN Code	KL (€)
B-NP450	64-66.5	VTR	8019002107718	435	8019002107701	500
B-NP451	66.5-69	VTR	8019002107732	435	8019002107725	500
B-NP452	69-71.5	VTR	8019002107756	440	8019002107749	505
B-NP453	71.5-74	VTR	8019002107770	440	8019002107763	505
B-NP454	74-76.5	VTR	8019002107794	445	8019002107787	510
B-NP455	76.5-79	VTR	8019002107817	445	8019002107800	510
B-NP456	79-81.5	VTR	8019002107848	450	8019002107824	515
B-NP457	81.5-84	VTR	8019002107862	450	8019002107855	520
B-NP458	84-86.5	VTR	8019002107886	455	8019002107879	520
B-NP459	86.5-89	VTR	8019002107909	455	8019002107893	525
B-NP460	89-91.5	VTR	8019002107923	460	8019002107916	525

La zanca di fissaggio a muro è di serie e compresa nel prezzo.
The bracket wall is standard and included in the price.

Prezzi IVA esclusa
Price VAT not included

Il modello si compone di n° colli di spedizione: 1
The model is composed of n° packings: 1



Prodotti speciali: Prezzo di listino + 40%
Special products: Price List + 40%

ARPA

Parete fissa per abbinamenti

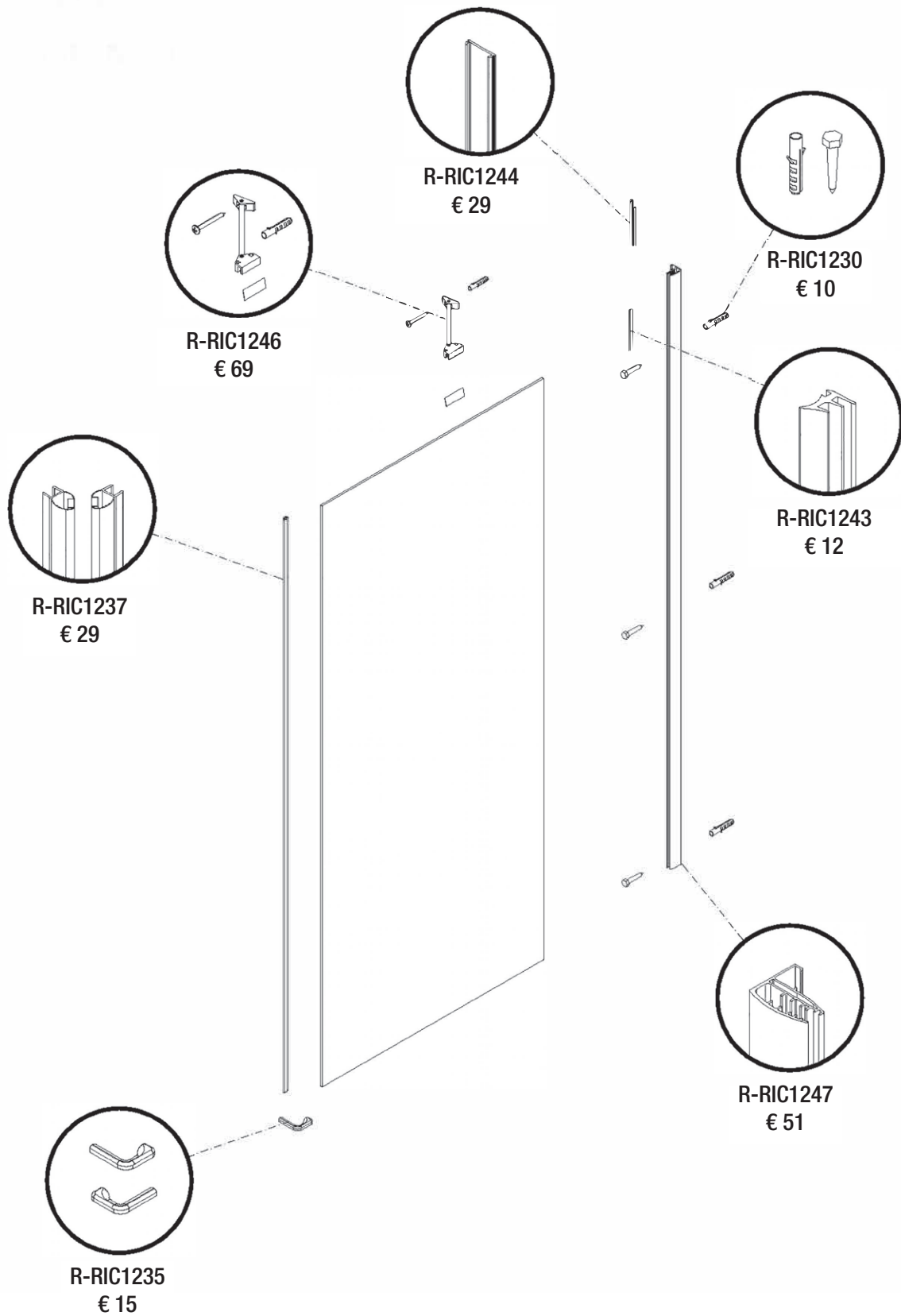



VTR



VST



VSQ

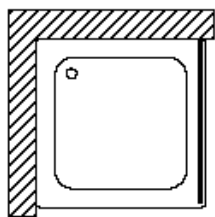

Parete fissa per abbinamenti
Non è possibile formare cabine doccia a 3 lati

Fixed panel for combination
It's impossible to form 3 sides shower enclosures

Articolo Article	Estensibilità (cm) Extension	Finitura Pannelli Panels Finishing	Codice EAN EAN Code	L1 (€)	Codice EAN EAN Code	KL (€)
B-0C24	67-69	VTR	8019002105332	180	8019002105363	190
		VST	8019002105325	190	8019002105356	200
		VSQ	8019002105318	200	8019002105349	210
B-0C26	77-79	VTR	8019002105394	190	8019002105424	200
		VST	8019002105387	200	8019002105417	210
		VSQ	8019002105370	210	8019002105400	220
B-0C28	87-89	VTR	8019002105455	200	8019002105486	210
		VST	8019002105448	210	8019002105479	220
		VSQ	8019002105431	220	8019002105462	230
B-0C29	97-99	VTR	8019002105516	210	8019002105547	220
		VST	8019002105509	220	8019002105530	230
		VSQ	8019002105493	230	8019002105523	240

Prezzi IVA esclusa
Price VAT not included

Il modello si compone di n° colli di spedizione: 1
The model is composed of n° packings: 1



Prodotti speciali: Prezzo di listino + 40%
Special products: Price List + 40%

ORCHESTRA

Parete fissa per abbinamenti

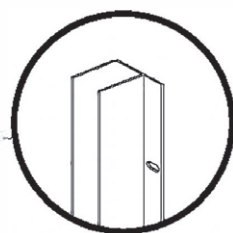
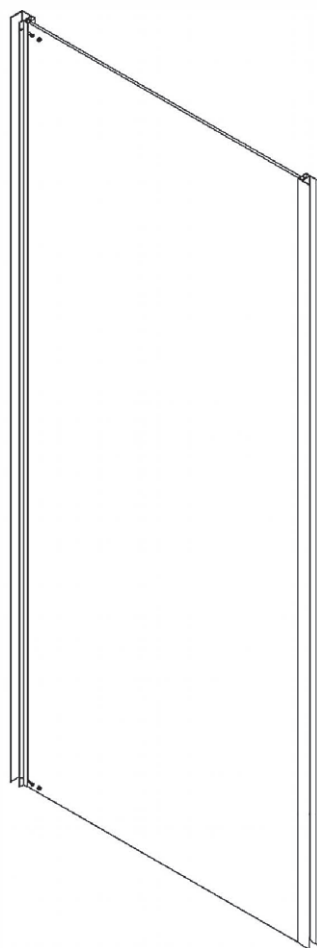

R-RIC1345
€ 40



R-RIC1341
€ 12

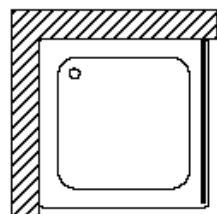

Parete fissa per abbinamenti
E' possibile formare cabine doccia a 2 o 3 lati

Fixed panel for combination
to form 2 or 3 sides shower enclosures

Articolo Article	Estensibilità (cm) Extension	Finitura Pannelli Panels Finishing	Codice EAN EAN Code	L1 (€)	Codice EAN EAN Code	KL (€)
B-EX819	66-68	VTR			8019002068453	290
		VST	8019002068484	265		
B-EX820	76-78	VTR			8019002068460	315
		VST	8019002068491	280		
B-EX821	86-88	VTR			8019002068477	335
		VST	8019002068507	290		

Prezzi IVA esclusa
Price VAT not included

MARACAS

Parete fissa per abbinamenti

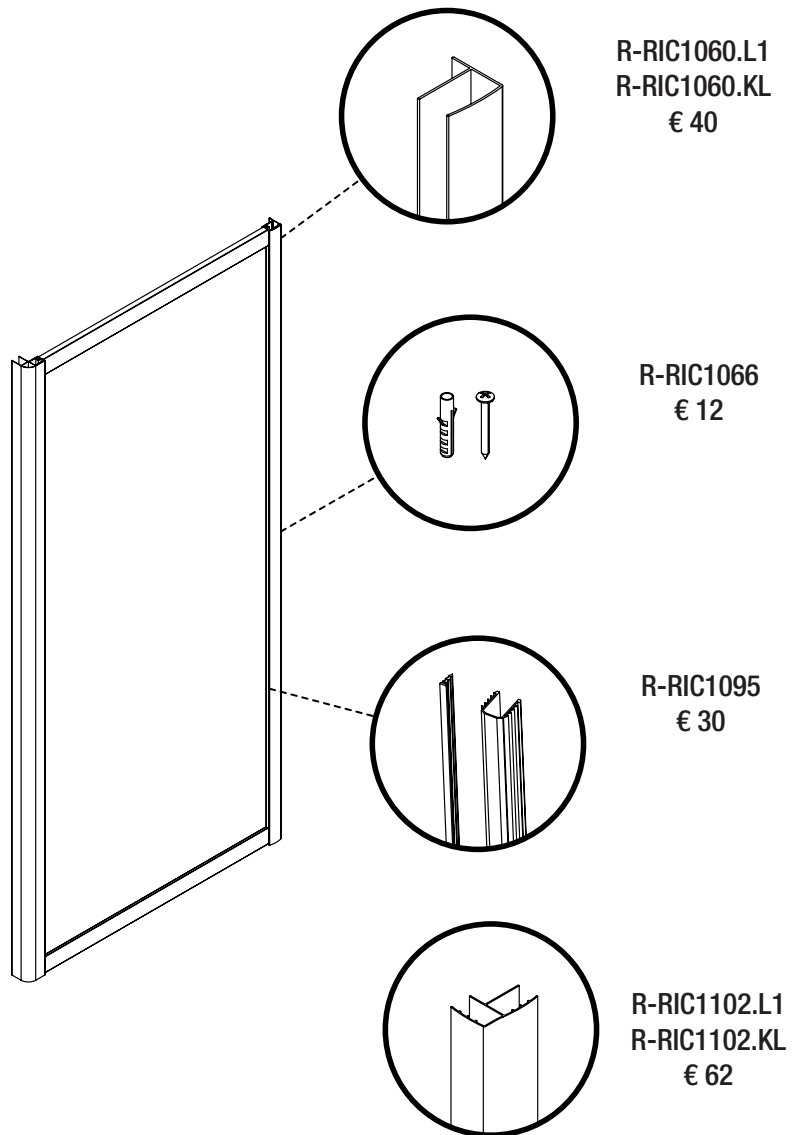

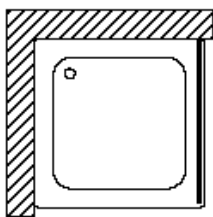
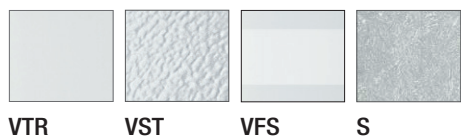

Parete fissa per abbinamenti
E' possibile formare cabine doccia a 2 o 3 lati

Fixed panel for combination
to form 2 or 3 sides shower enclosures

Articolo Article	Estensibilità (cm) Extension	Finitura Pannelli Panels Finishing	Codice EAN EAN Code	L1 (€)	Codice EAN EAN Code	KL (€)
B-PA671	69-73	VTR	8019002087287	160	8019002087270	220
		VST	8019002087263	170	8019002087256	245
		VFS	8019002087249	200	8019002087232	275
		S	8019002087225	140	8019002087218	195
B-PA673	77-81	VTR	8019002087362	160	8019002087355	220
		VST	8019002087348	170	8019002087331	245
		VFS	8019002087324	200	8019002087317	275
		S	8019002087300	140	8019002087294	195
B-PA675	85-89	VTR	8019002087447	160	8019002087430	225
		VST	8019002087423	170	8019002087416	245
		VFS	8019002087409	200	8019002087393	275
		S	8019002087386	140	8019002087379	195

Prezzi IVA esclusa
Price VAT not included

Il modello si compone di n° colli di spedizione: 1
The model is composed of n° packings: 1



Prodotti speciali: Prezzo di listino + 40%
Special products: Price List + 40%

TENORE

Parete fissa per abbinamenti

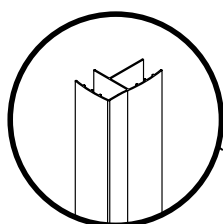

RIC1387L01
RIC1387ULU
€ 36

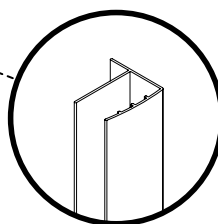

RIC1385L01
RIC1385ULU
€ 24

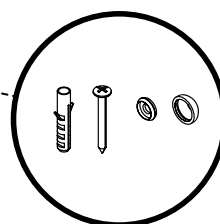

RIC845
€ 10

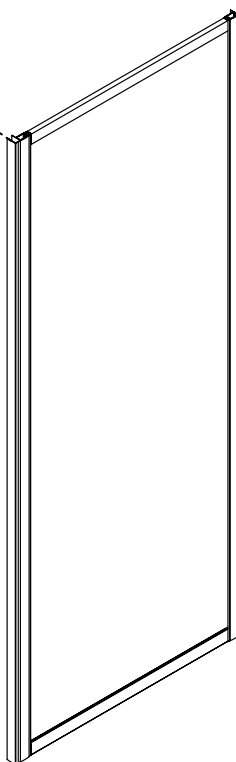

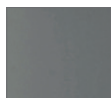

GR



CH



SK

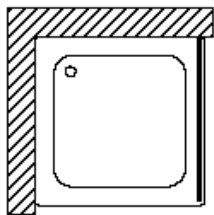

Parete fissa per abbinamenti

Fixed panel for combination

Articolo Article	Estensibilità (cm) Extension	Finitura Pannelli Panels Finishing	Codice EAN EAN Code	KL (€)
B-IMPFF70	68-70	CH	8019002101334	240
		GR	8019002102522	240
		SK	8019002102584	275
B-IMPFF80	78-80	CH	8019002101136	250
		GR	8019002102539	250
		SK	8019002102591	285

Prezzi IVA esclusa
Price VAT not included

VIOLINO

Parete fissa per abbinamenti

R-RIC1200.KL
€ 40

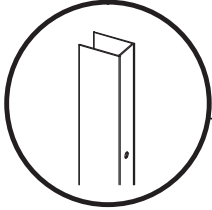

R-RIC1205.KL
€ 30

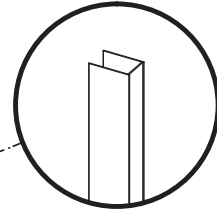

R-RIC1203.KL
€ 12

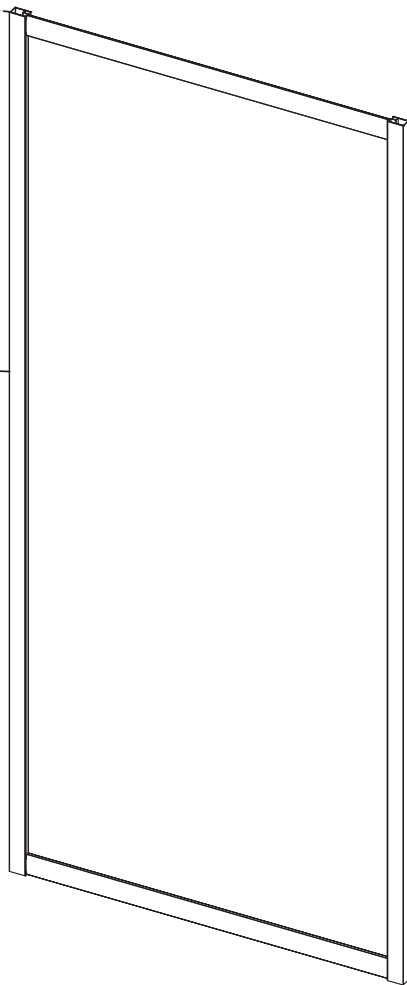
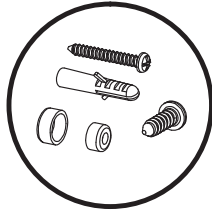



VTR



VST

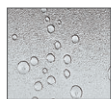

C

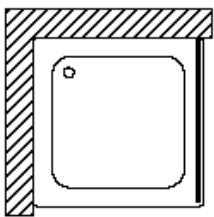

Parete fissa per abbinamenti
E' possibile formare cabine doccia a 2 o 3 lati

Fixed panel for combination
to form 2 or 3 sides shower enclosures

Articolo Article	Estensibilità (cm) Extension	Finitura Pannelli Panels Finishing	Codice EAN EAN Code	L1 (€)
B-GC571	69-73	VTR	8019002048325	160
		VST	8019002048332	170
		C	8019002048318	145
B-GC573	77-81	VTR	8019002048356	160
		VST	8019002048363	170
		C	8019002048349	145
B-GC575	85-89	VTR	8019002048387	160
		VST	8019002048394	170
		C	8019002048370	145

Prezzi IVA esclusa
Price VAT not included

Il modello si compone di n° colli di spedizione: 1
The model is composed of n° packings: 1



Prodotti speciali: Prezzo di listino + 40%
Special products: Price List + 40%

FIATI

Parete fissa per abbinamenti

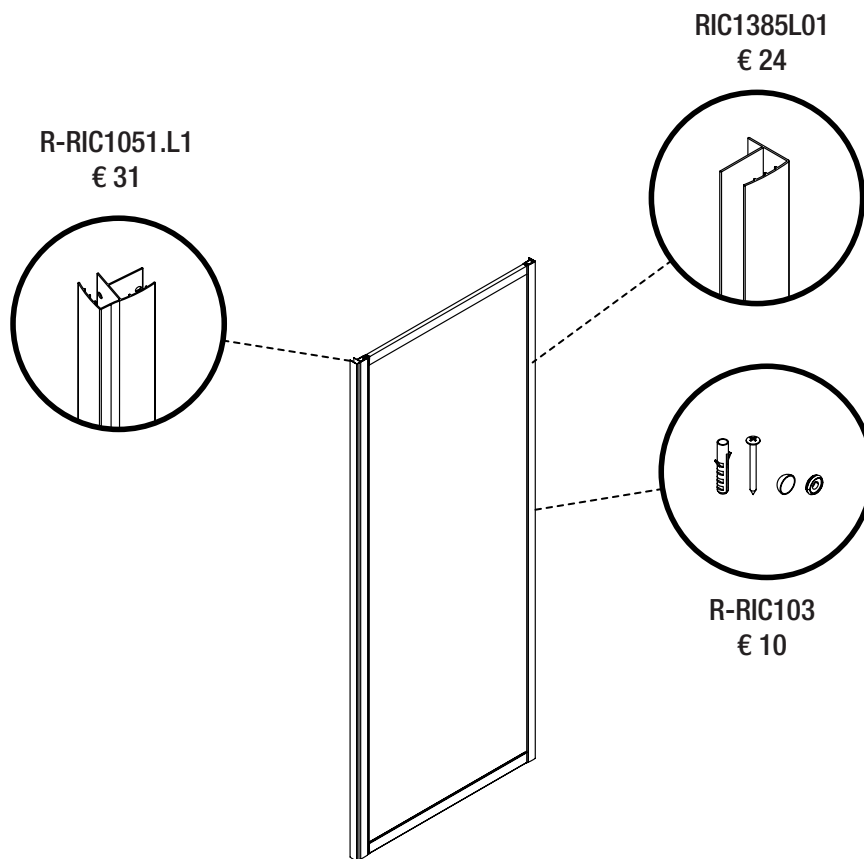

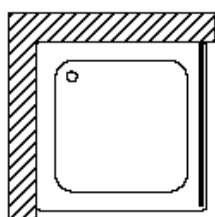
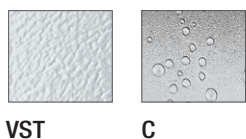

Parete fissa per abbinamenti
E' possibile formare cabine doccia a 2 o 3 lati

Fixed panel for combination
to form 2 or 3 sides shower enclosures

Articolo Article	Estensibilità (cm) Extension	Finitura Pannelli Panels Finishing	Codice EAN EAN Code	L1 (€)
B-SI2160	68-71	VST	8019002080004	160
B-SI2105C		C	8019002041937	135
B-SI2170	78-81	VST	8019002080011	160
B-SI2105C2		C	8019002053138	135
B-SI2180	88-91	VST	8019002080028	160
B-SI2105C3		C	8019002079992	135

Per il montaggio della parete fissa da sola come divisorio occorre acquistare a parte il profilo a muro: R-RIC1049

Prezzi IVA esclusa
Price VAT not included

**L'abbinamento con angolo e/o porta aumenta la misura finale della parete fissa e dell'angolo/porta di 1,5 cm.
Es. B-SI2160 + B-SI2025: B-SI2160 anzichè 68-71 diventa 69,5-72,5, mentre B-SI2025 anzichè 89-92 diventa 90,5-93,5**

OPERA

Parete fissa per abbinamenti

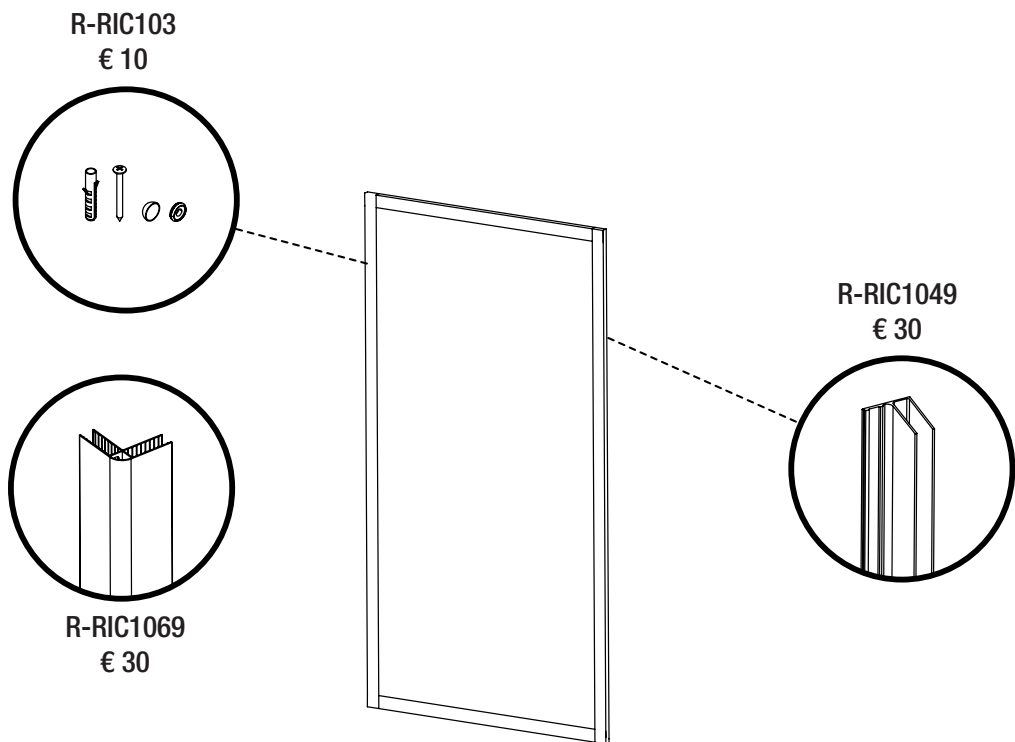



optionals:



VTR



Cabina doccia frontale o angolare

Cabina doccia spaziosa caratterizzata da area di accesso dedicata e anta fissa. Il vano di accesso alla doccia è libero, senza porta, con apertura di cm. 80. È possibile il montaggio anche senza piatto doccia: una guarnizione inferiore consente di isolare la parete in vetro dal piano di appoggio.

Frontal or angular shower enclosure

Spacious shower enclosure, featured by dedicated access area and fixed panel. The access area to the shower is open, doorless, with opening cm. 80. Possible installation also without shower tray: a lower gasket allows to isolate the glass panel from the supporting surface.

Articolo Article	Estensibilità (cm) Extension	Finitura Pannelli Panels Finishing	Codice EAN EAN Code	KL (€)
B-F980	76-79	VTR	8019002060228	355
B-F981	96-99	VTR	8019002060235	410
B-F982	116-119	VTR	8019002060242	440
B-F983	136-139	VTR	8019002087157	490

K800KG:

n. 1 kit cm 80 di sostegno vetro-muro di serie e compreso nell'imballo.
n. 1 kit cm 80 for support glass panel is standard and included in the pack.

Prezzi IVA esclusa
Price VAT not included

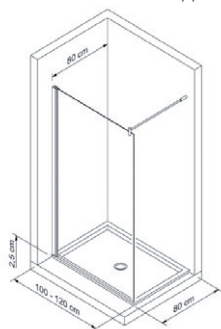

Combinazione A
Combination A

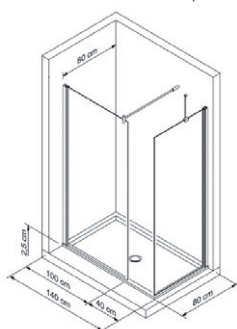

Combinazione B
Combination B

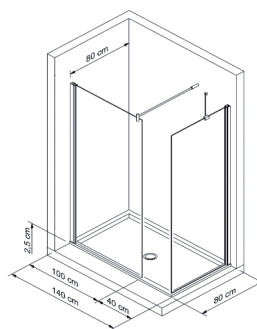

Combinazione C
Combination C

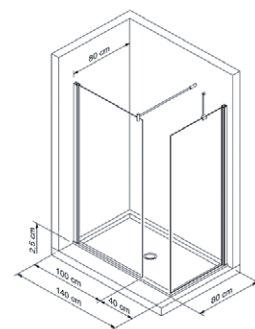

Combinazione D
Combination D

Il modello si compone di n° colli di spedizione: 1
The model is composed of n° packings: 1



Prodotti speciali: Prezzo di listino + 40%
Special products: Price List + 40%

FREE 30

Piatto doccia optional

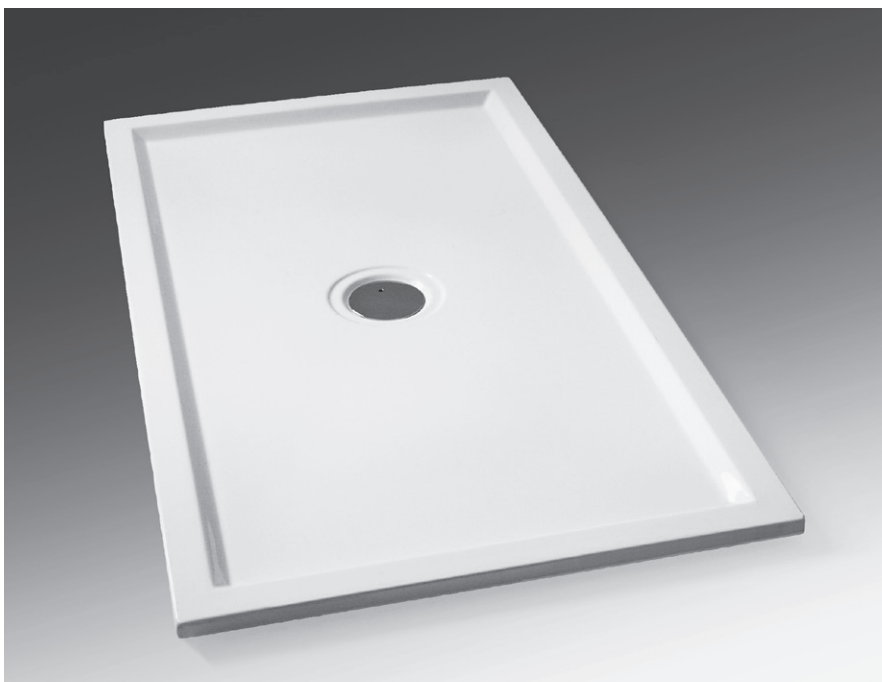
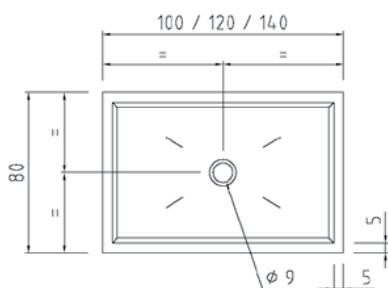

Optional su richiesta:
piatto doccia dedicato, Metacrilato bianco.

Optional upon request:
dedicated shower tray, white Methacrylate.

Articolo Article	Misure Max Ingombro (cm) Dimension	Altezza (cm) Height	Codice EAN EAN Code	(€)
D4980L01	100X80	2,5	8013207604713	435
D4981L01	120X80	2,5	8013207604720	495
D4982L01	140X80	2,5	8013207604737	560

Installazione: incassato con appoggio a pavimento
Installation: embedded and placed on the floor

Prezzi IVA esclusa
Price VAT not included

Zanca di fissaggio ad angolo vetro-muro
Corner fixing device glass-wall

Articolo Article	Cromo (€) Chrome
K254PULU	87

Kit di sostegno vetro-muro
Kit for support glass panel

Articolo Article	A (cm) Chrome	Cromo (€) Chrome
KT1000A1	97-100	137
RIC1215C	77-80	111

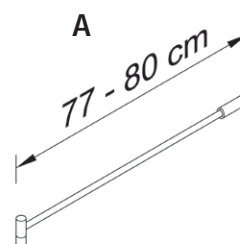
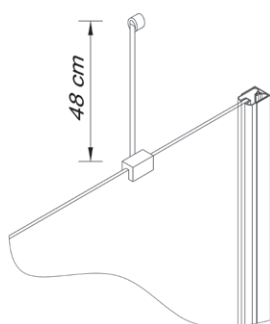

Prodotti speciali non disponibili
Special products not available

FREE 20



VTR

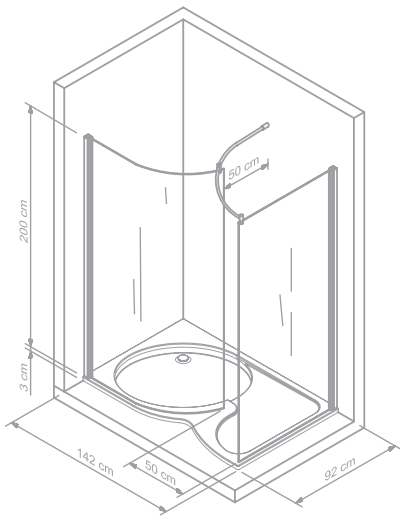

Angolo con due pareti

Cabina doccia spaziosa caratterizzata da area di accesso dedicata e due pareti fisse. Il vano di accesso alla doccia è libero, senza porta, con apertura cm 50. È possibile il montaggio anche senza piatto doccia: una guarnizione inferiore consente di isolare le pareti in vetro dal piano di appoggio. RIC 830

Corner shower with two panels

Spacious shower enclosure, featured by dedicated access area and two fixed panels. The access area to the shower is open, doorless, with opening cm 50. Possible installation also without shower tray: a lower gaskets allows to isolate the glass panels from the supporting surface.

Articolo Article	Estensibilità (cm) Extension	Finitura Pannelli Panels Finishing	Codice EAN EAN Code	KL (€)
B-F950	140X90 *	VTR	8019002086976	800

* dimensioni senza piatto doccia
* size without shower tray

Prezzi IVA esclusa
Price VAT not included

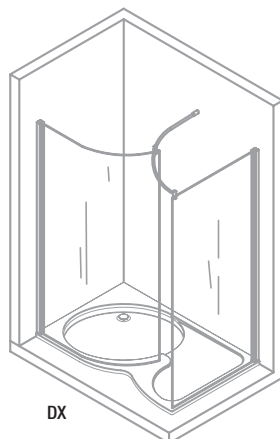
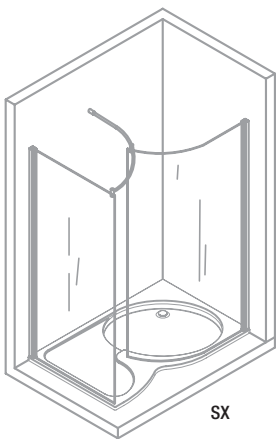

Il modello si compone di n° colli di spedizione: 2
The model is composed of n° packings: 2

Prodotti speciali: NON DISPONIBILI
Special products: NOT AVAILABLE

FREE 20

Piatto doccia optional

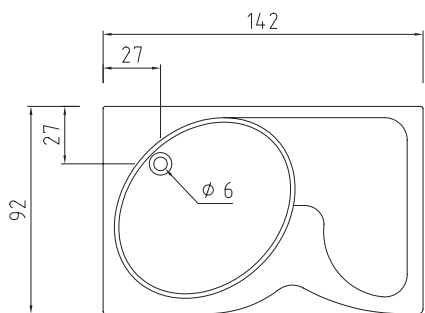

DX

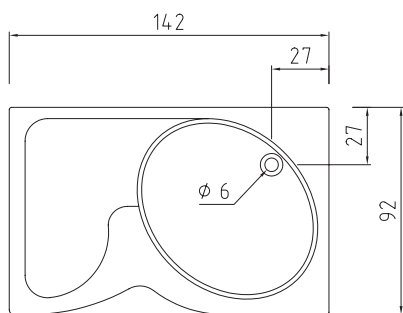

SX



Optional su richiesta:
piatto doccia dedicato, finitura Metacrilato
bianco; specificare se DX o SX.

Optional upon request:
dedicated shower tray, white Methacrylate
finishing; to be specify if DX or SX.

Articolo Article	Misure Max Ingombro (cm) Dimension	Altezza (cm) Height	Codice EAN EAN Code	(€)
D4950L01SX	142X92	3	8013207472565	450
D4950L01DX			8013207472558	

Prezzi IVA esclusa
Price VAT not included

Installazione: incassato con appoggio a pavimento
Installation: embedded and placed on the floor

Non reversibile: specificare se versione DX o SX
Not reversible: to be specify if DX or SX

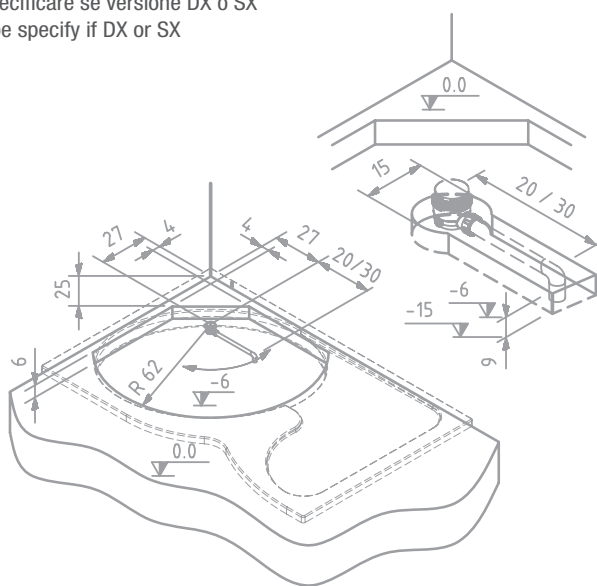
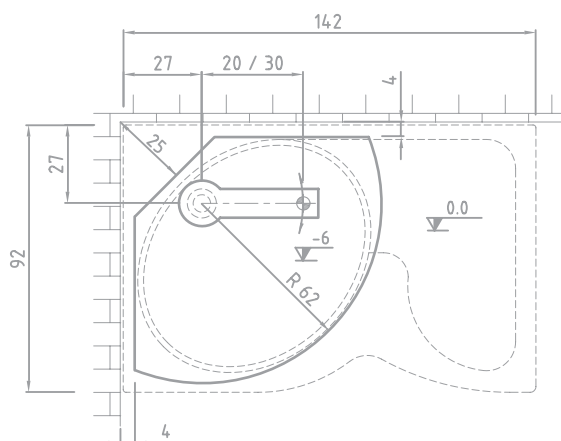

Il modello si compone di n° colli di spedizione: 1
The model is composed of n° packings: 1



Prodotti speciali non disponibili
Special products not available

FREE 30

Cabina doccia angolare o frontale

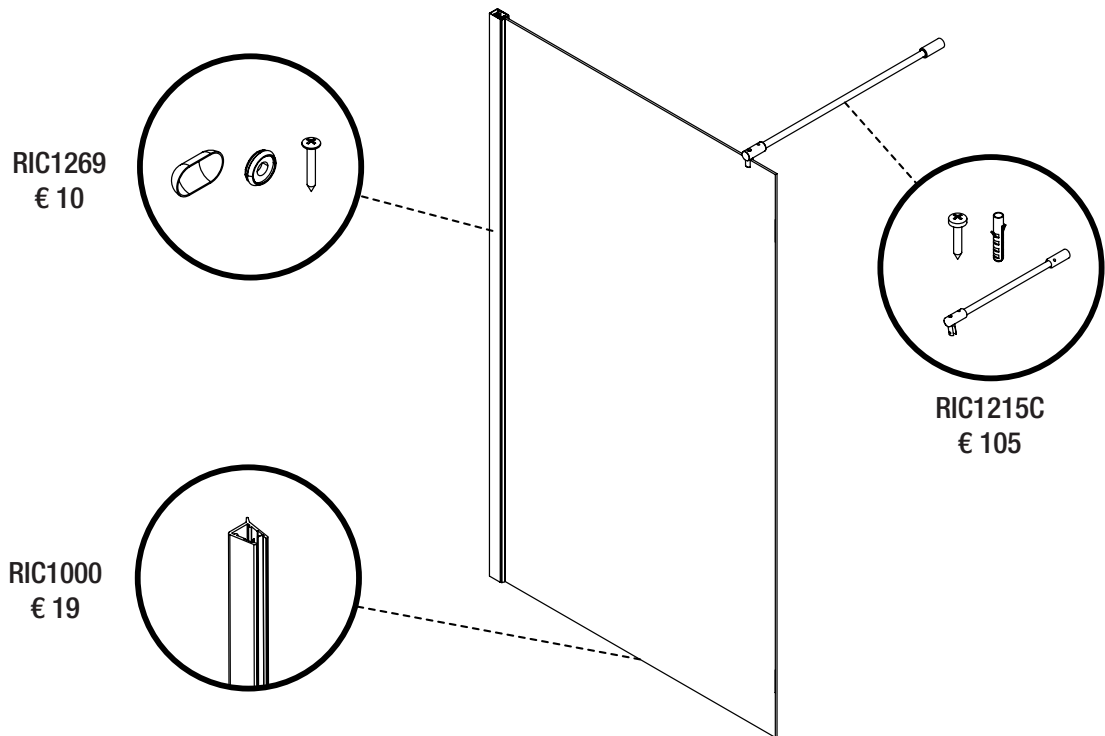

FREE 20

Cabina doccia angolare

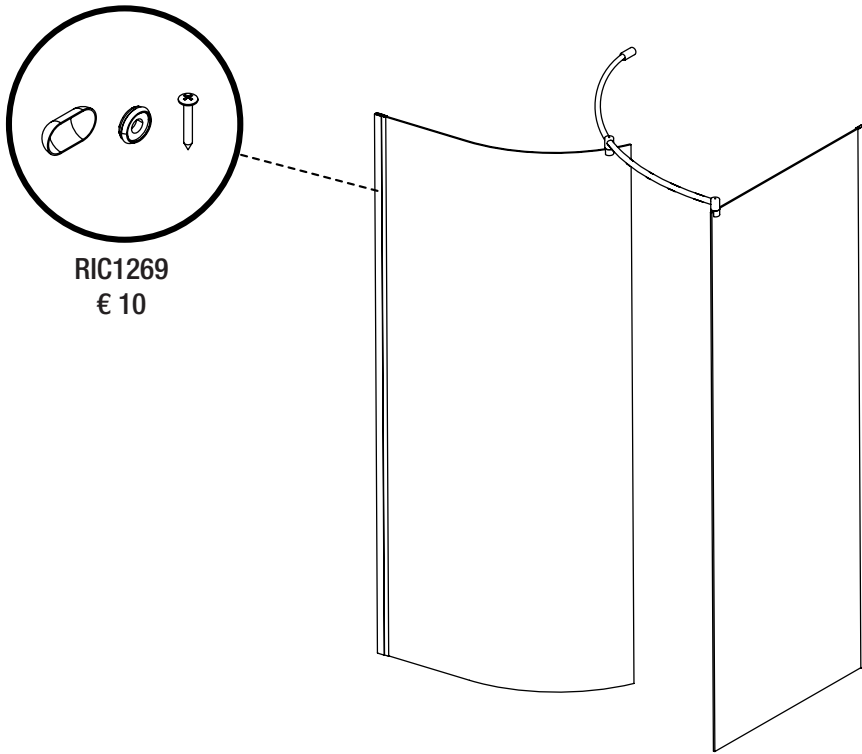

RIC1269
€ 10

FREE

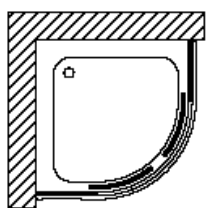
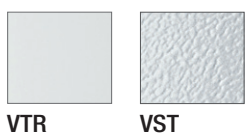
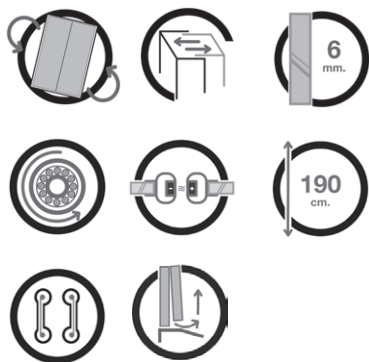

Tondo scorrevole a quattro ante
Due ante fisse laterali e due apribili frontali
Raggio di curvatura non costante: 55 cm

Round enclosure with four panels
Central opening with sliding panels, two lateral
fixed and two frontal can be opened.
Not constant radius: 55 cm

Articolo Article	Estensibilità (cm) Extension	Finitura Pannelli Panels Finishing	Codice EAN EAN Code	L1 (€)	Codice EAN EAN Code	KL (€)
B-EX872	86-90	VTR			8019002086969	720
		VST	8019002077882	615		
B-EX873	76-80	VTR			8019002085054	660
		VST	8019002085047	570		

Prezzi IVA esclusa
Price VAT not included

MARACAS

Tondo scorrevole a quattro ante

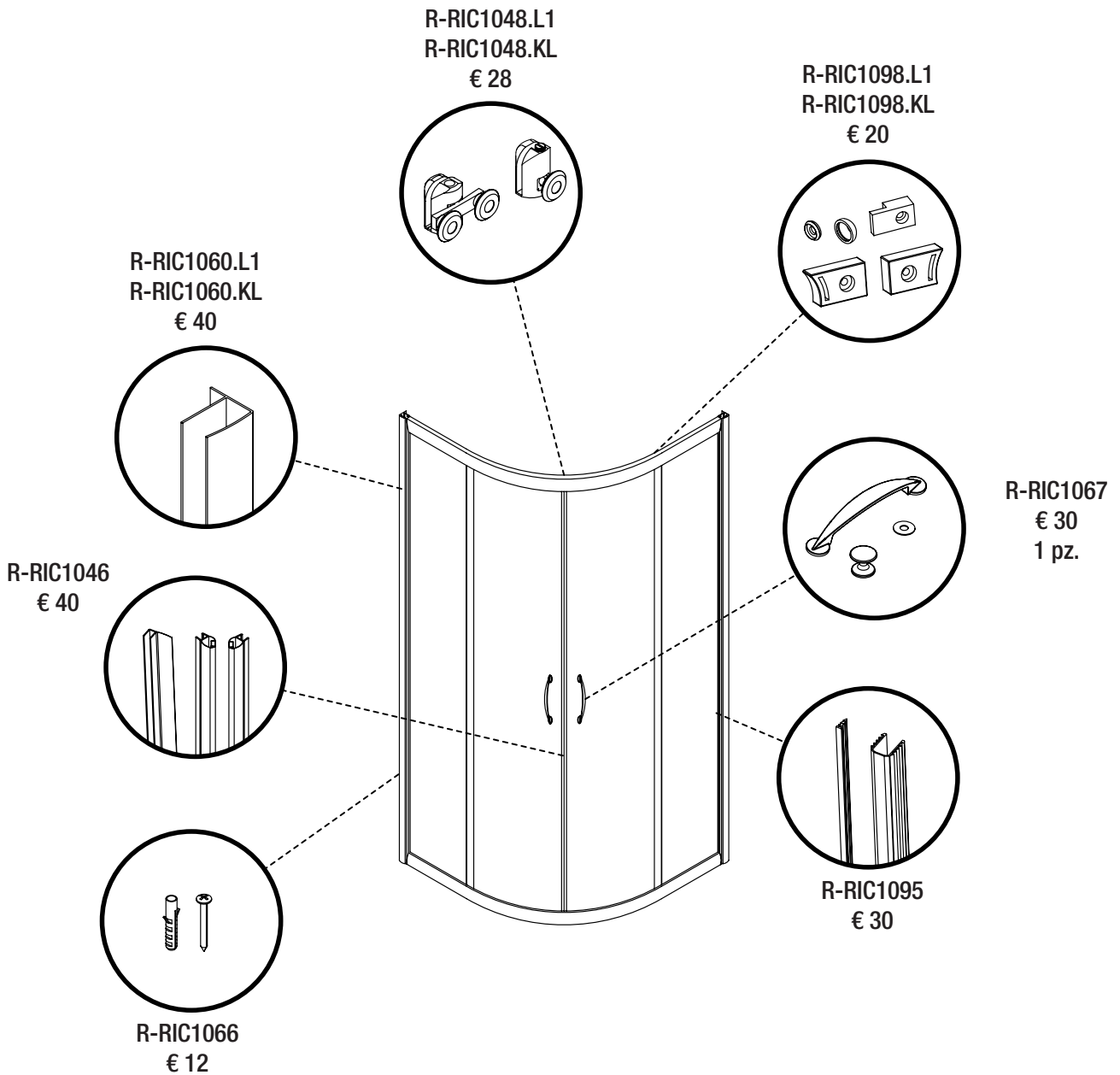

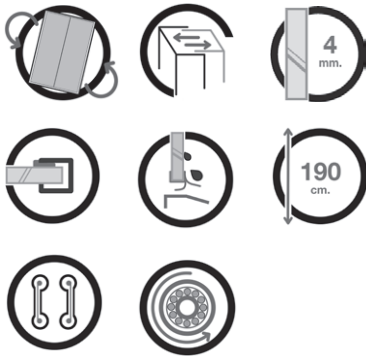

GR



CH



SK

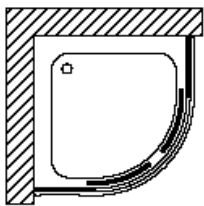

Tondo scorrevole a quattro ante
Due ante fisse laterali e due apribili frontali
Raggio di curvatura non costante: 55 cm

Round enclosure with four panels
Central opening with sliding panels, two lateral
fixed and two frontal can be opened.
Not constant radius: 55 cm

Articolo Article	Estensibilità (cm) Extension	Finitura Pannelli Panels Finishing	Codice EAN EAN Code	KL (€)
B-IMPT80	77-79	CH	8019002101129	330
		GR	8019002102515	350
		SK	8019002102577	350

Prezzi IVA esclusa
Price VAT not included

VIOLINO

Tondo scorrevole a quattro ante

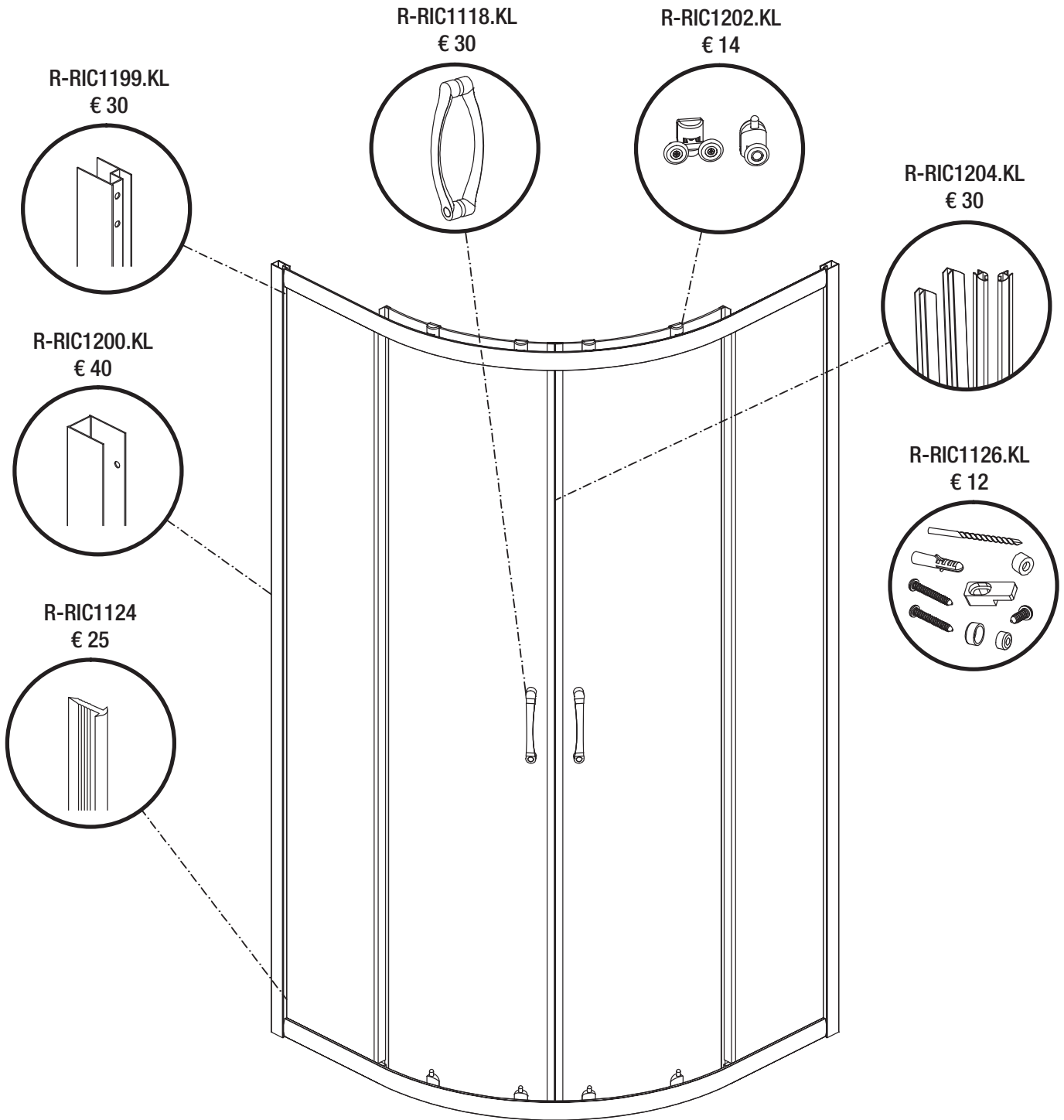

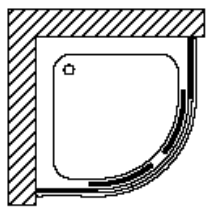
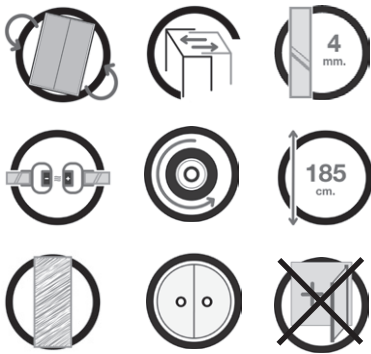

Tondo scorrevole a quattro ante
Due ante fisse laterali e due apribili frontali
Raggio di curvatura non costante: 55 cm

Round enclosure with four panels
Central opening with sliding panels, two lateral
fixed and two frontal can be opened.
Not constant radius: 55 cm

Articolo Article	Estensibilità (cm) Extension	Finitura Pannelli Panels Finishing	Codice EAN EAN Code	L1 (€)
B-SIX052	76-78	VTR	8019002707406	410
		VST	8019002033772	420
		C	8019002033765	410
B-SIX053	86-88	VTR	8019002036582	430
		VST	8019002033390	440
		C	8019002033444	430
B-SIX054	71-73 R.38	VTR	8019002036612	410
		VST	8019002036605	420
		C	8019002036599	410

Non abbinabile a parete fissa
Not to match with fixed panel

Prezzi IVA esclusa
Price VAT not included

Il modello si compone di n° colli di spedizione: 1
The model is composed of n° packings: 1



Prodotti speciali: Prezzo di listino + 40%
solo per finitura C in acrilico con altezza
inferiore allo standard

Special products: Price List + 40%
only for C finishing with lower height than the
standard measurement

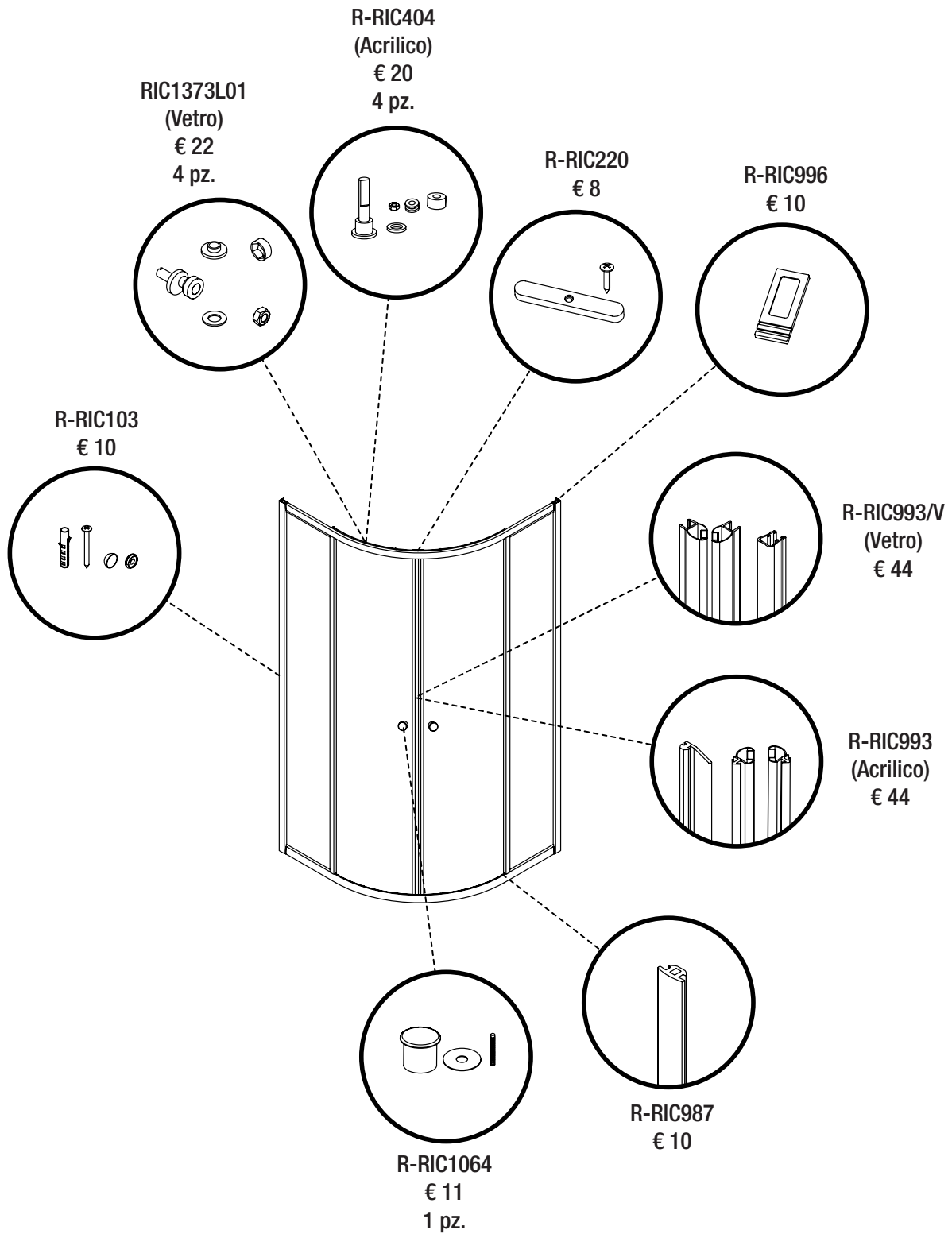

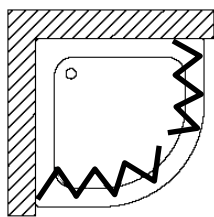

Tondo PVC riducibile
Apertura ad ante pieghevoli

Round unit PVC reducible
Opening with folding panels

Articolo Article	Estensibilità (cm) Extension	Finitura Pannelli Panels Finishing	Codice EAN EAN Code	L1 (€)
B-PV120	80X80	PVC	8019002054050	350
B-PV121	90X90	PVC	8019002054067	360

Non abbinabile a parete fissa
Not to match with fixed panel

Prezzi IVA esclusa
Price VAT not included

Questo prodotto è riducibile alla misura desiderata, basta tagliare il binario ed eliminare le stecche fino ad ottenere la misura desiderata.
This product can be reduced to the desired size, simply cut the track and eliminate the sticks until you get the desired size.

Il modello si compone di n° colli di spedizione: 1
The model is composed of n° packings: 1

Prodotti speciali: NON DISPONIBILI
Special products: NOT AVAILABLE

SIPARIO

Tondo con ante ripiegabili

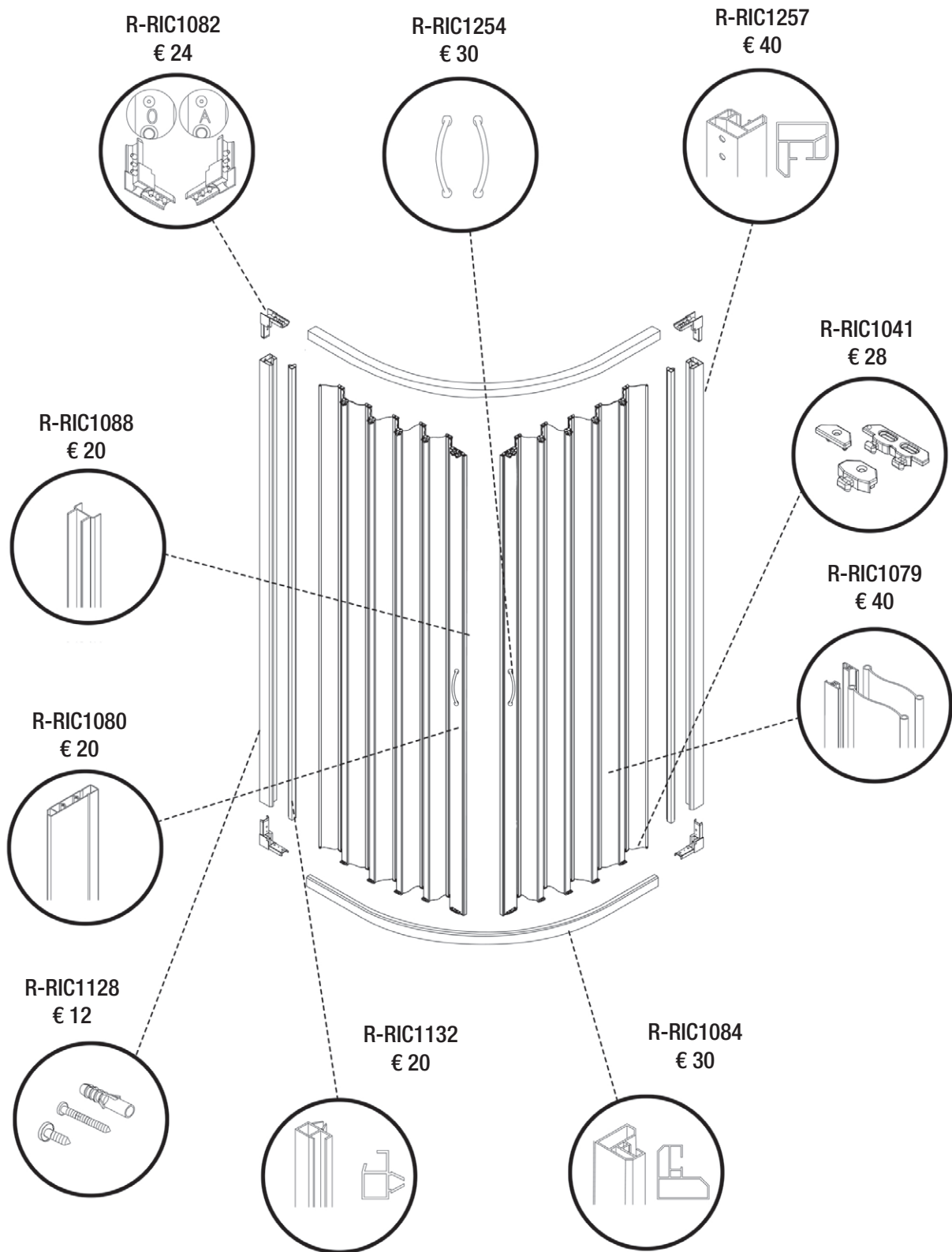

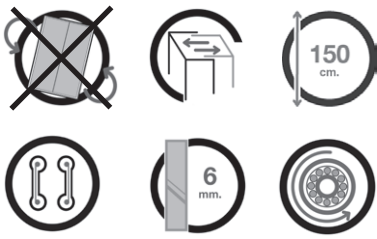

VTR



Rototraslante

Rototraslante

Articolo Article	Estensibilità (cm) Extension	Finitura Pannelli Panels Finishing	Codice EAN EAN Code	KL (€)
B-TWI450/DX	84-116	VTR	8019002075178	890
B-TWI450/SX			8019002074690	

Prezzi IVA esclusa
Price VAT not included

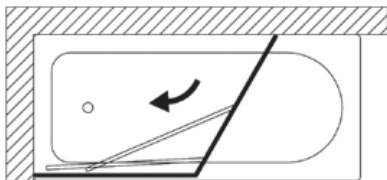

SX

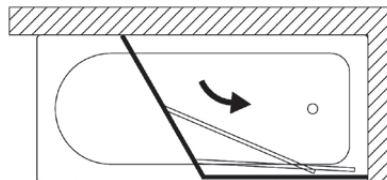

DX

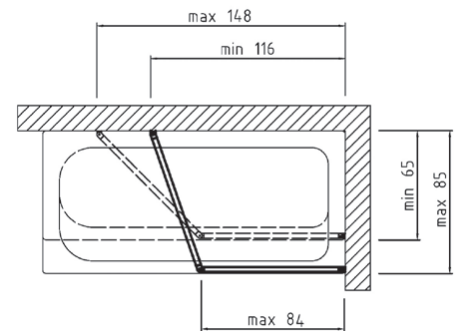

Il modello si compone di n° colli di spedizione: 1
The model is composed of n° packings: 1

Prodotti speciali: NON DISPONIBILI
Special products: NOT AVAILABLE

TWIST

Cabina vasca con apertura rototraslante

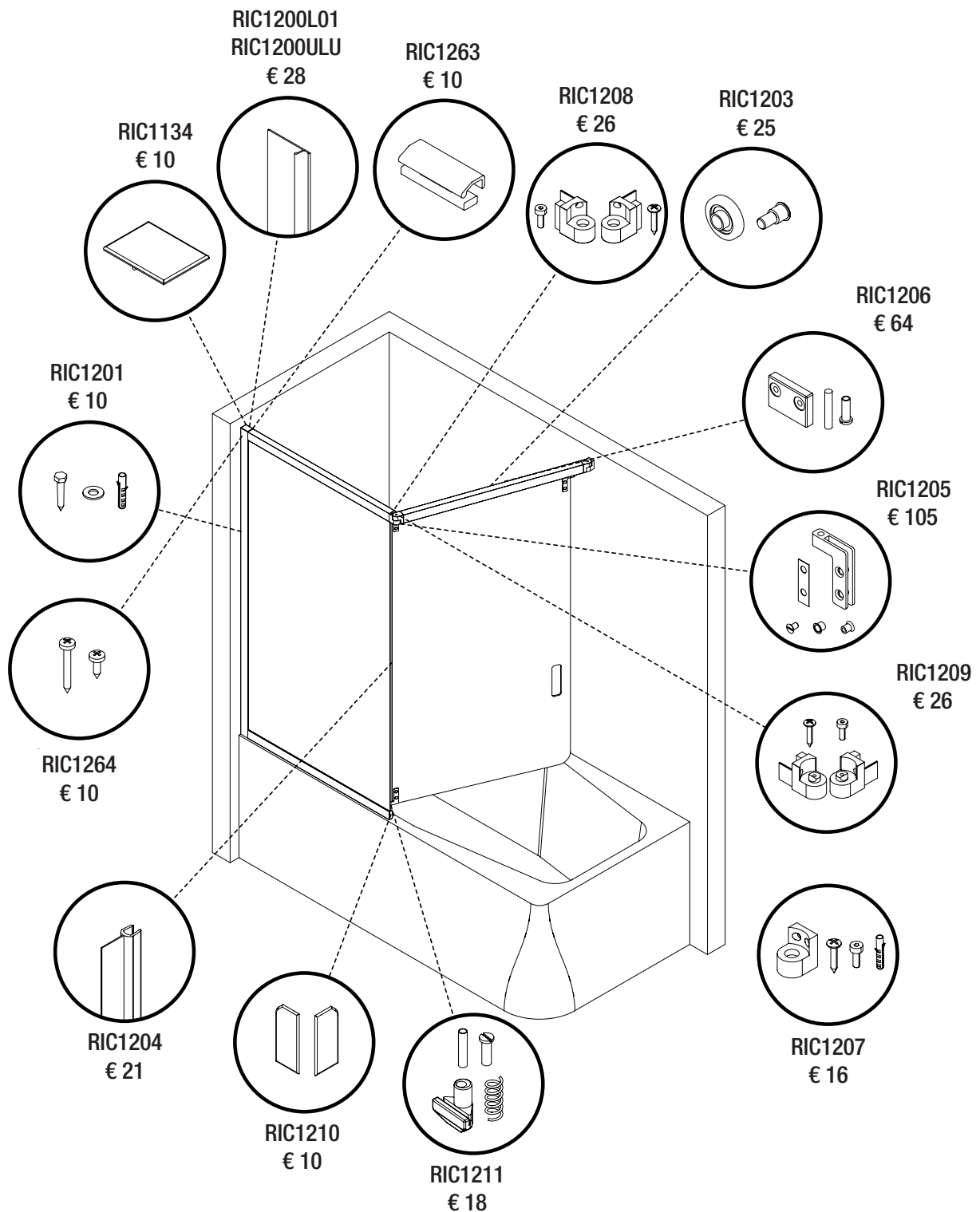

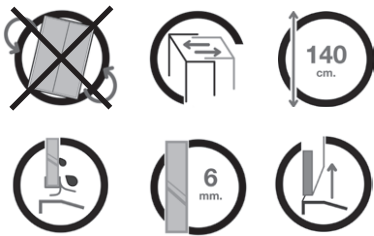

VTR

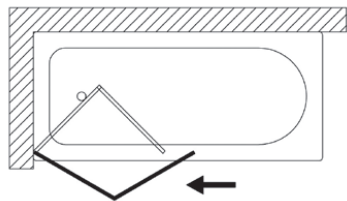

Parete pieghevole a 2 ante per vasca
Apertura verso l'interno e verso l'esterno

Two folding panels bath screen
Inwards and outwards opening

Articolo Article	Estensibilità (cm) Extension	Finitura Pannelli Panels Finishing	Codice EAN EAN Code	L1 (€)	Codice EAN EAN Code	KL (€)
B-OLY197	120-122	VTR	8019002068804	450	801900206881	525

Prezzi IVA esclusa
Price VAT not included

TWIST

Parete vasca a due ante una pieghevole

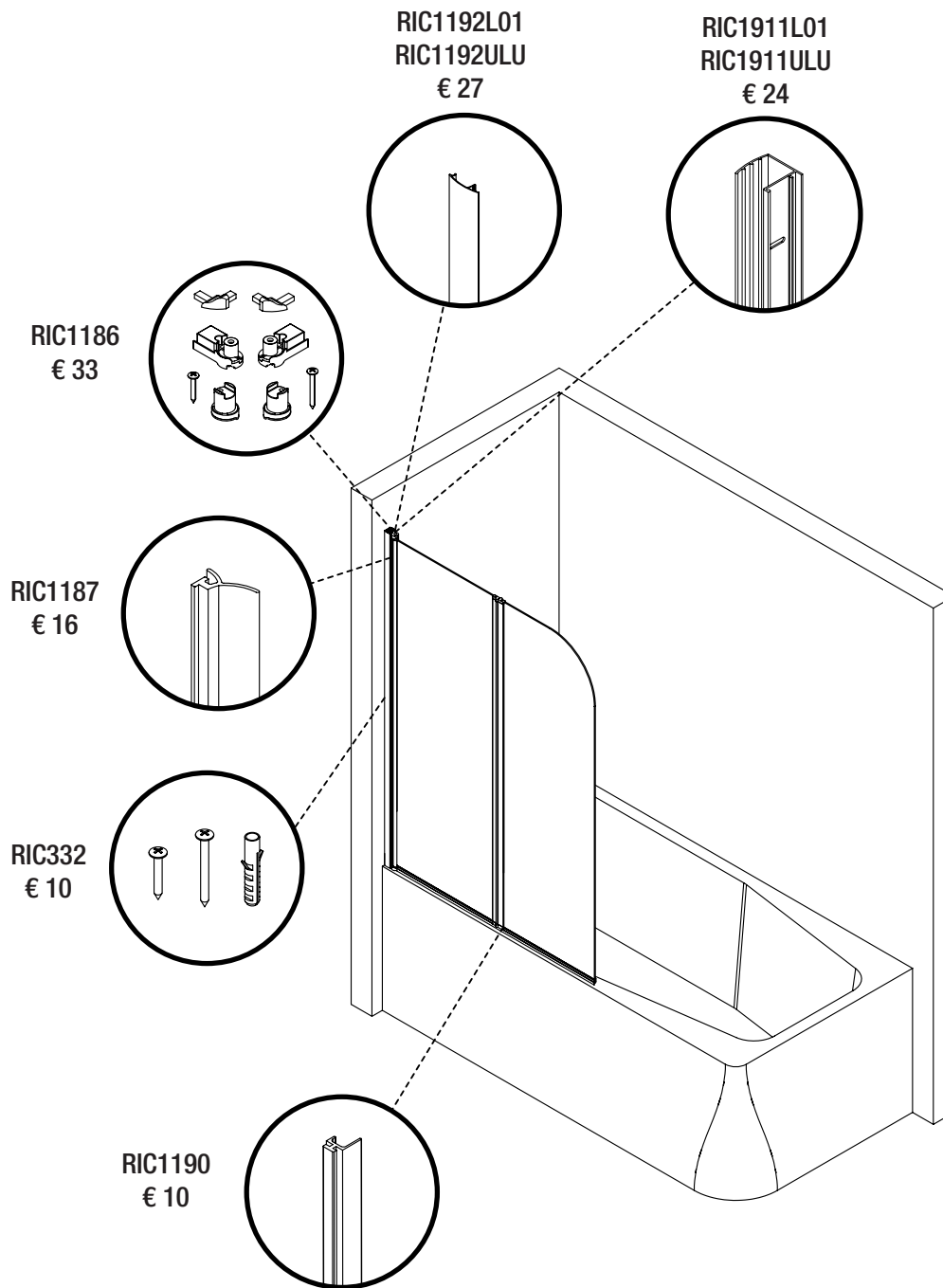



VTR



Parete per vasca ad un'anta con maniglione
Apertura verso l'interno e verso l'esterno

Pivot bath screen with big handle
Inwards and outwards opening

Articolo Article	Estensibilità (cm) Extension	Finitura Pannelli Panels Finishing	Codice EAN EAN Code	L1 (€)	Codice EAN EAN Code	KL (€)
B-OLY100	75	VTR	8019002037053	240	8019002087546	285
B-OLY101*	75		8019002039644	210	8019002043627	265

* Senza maniglione
* Without big handle

Prezzi IVA esclusa
Price VAT not included

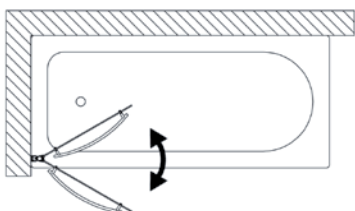

Il modello si compone di n° colli di spedizione: 1
The model is composed of n° packings: 1

Prodotti speciali: NON DISPONIBILI
Special products: NOT AVAILABLE

TWIST

Parete vasca ad un'anta con o senza maniglione

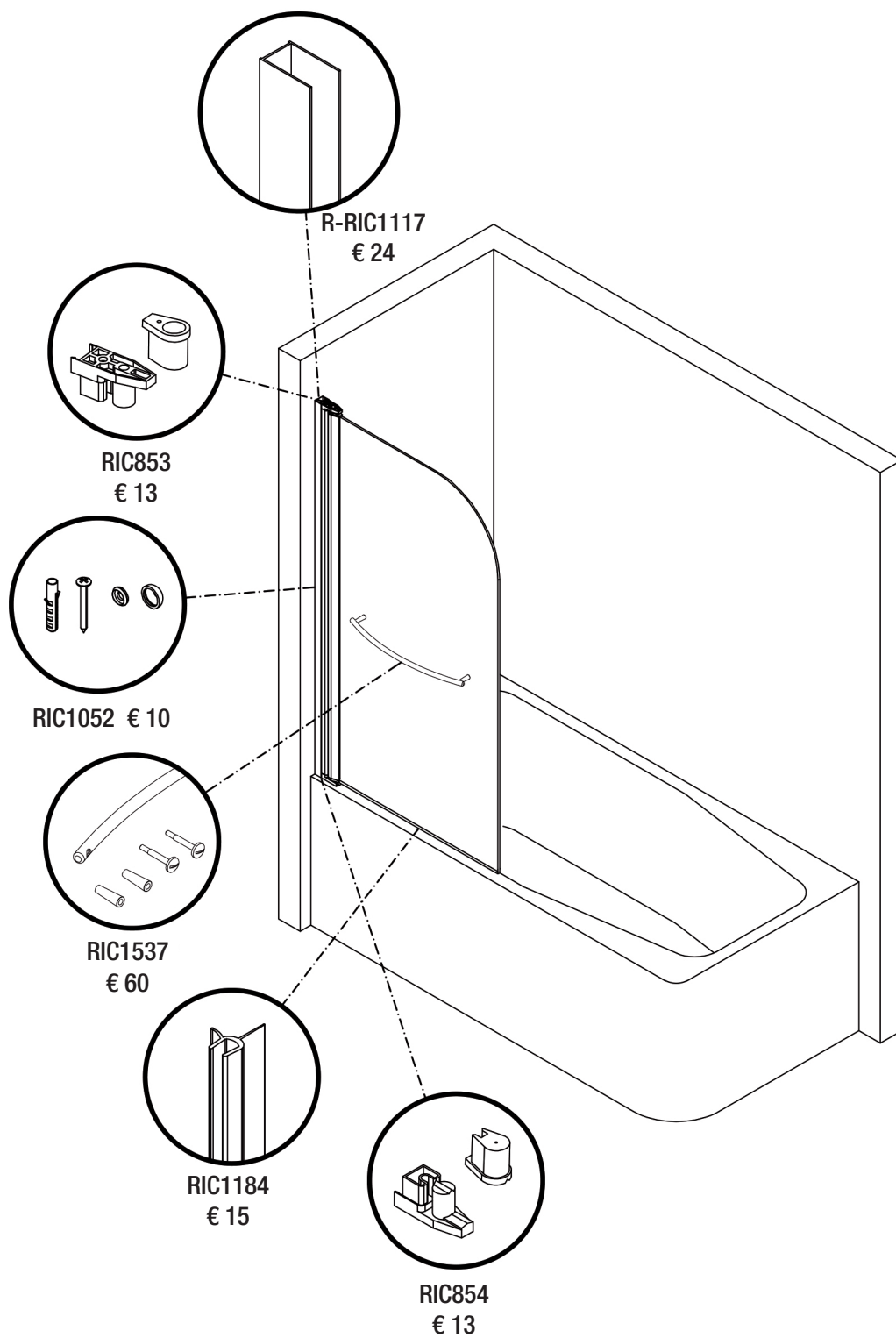



S

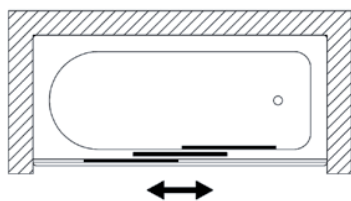

Parete vasca a tre ante scorrevoli
Due ante scorrevoli e una fissa

Three sliding panels bath screen
Lateral opening with sliding doors, one fixed and two can be opened

Articolo Article	Estensibilità (cm) Extension	Finitura Pannelli Panels Finishing	Codice EAN EAN Code	L1 (€)
B-PA692	156-160	S	8019002081254	310
B-PA695	168-172	S	8019002081261	315
B-PA697	176-180	S	8019002081278	320

Prezzi IVA esclusa
Price VAT not included

TENORE

Parete vasca a tre ante scorrevoli

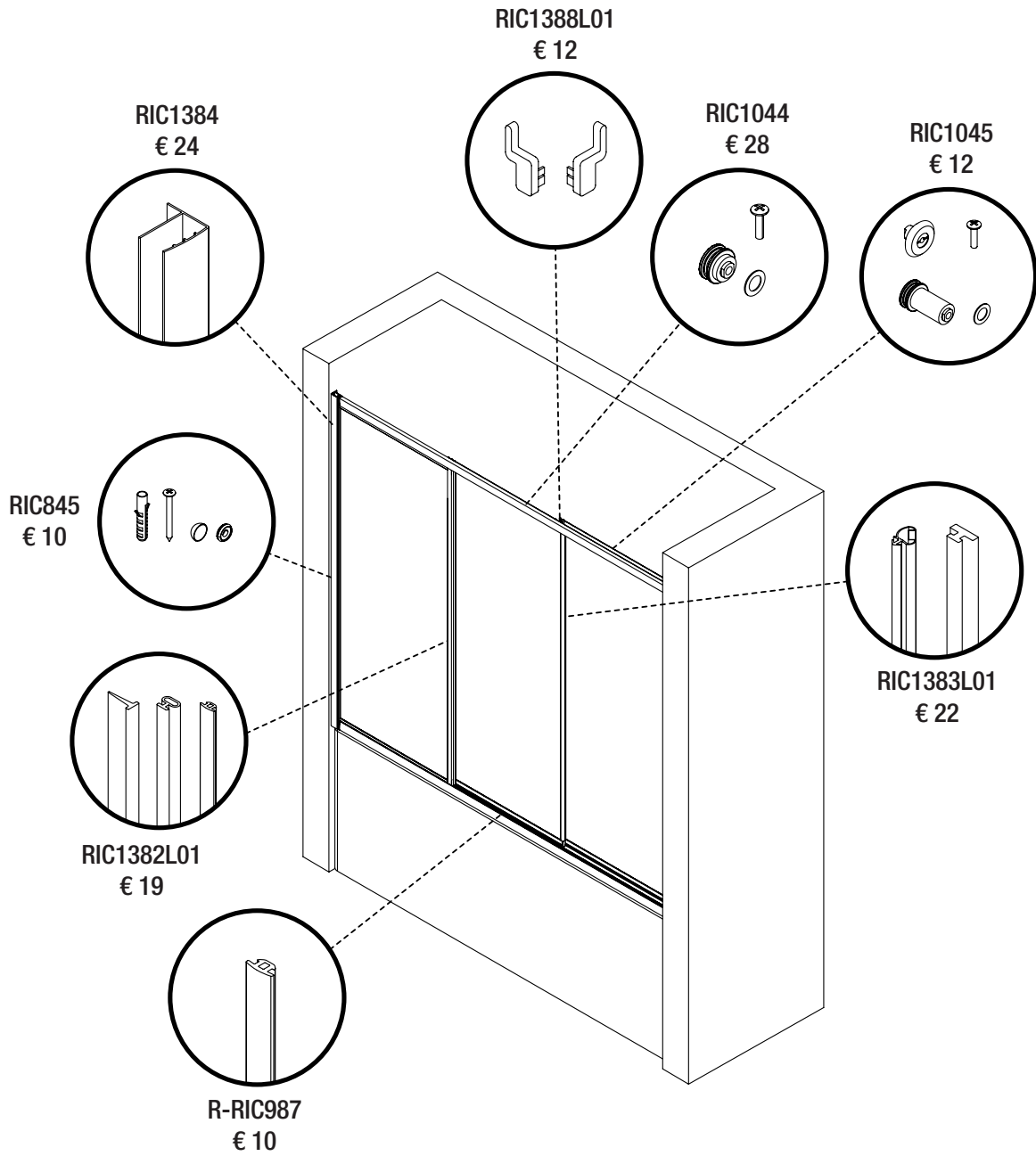



S



Parete vasca fissa per combinazione
Combinazioni per formare cabine vasca a due
o tre lati

Fixed panel bath screen
Suitable for combinations to form two or three
side bath screen

Articolo Article	Estensibilità (cm) Extension	Finitura Pannelli Panels Finishing	Codice EAN EAN Code	L1 (€)
B-PA681	68-72	S	8019002081285	150
B-PA683	76-80	S	8019002081292	160

Prezzi IVA esclusa
Price VAT not included

Per il montaggio della parete fissa da sola o come divisorio occorre acquistare a parte il profilo RIC 1384.
For mounting the fixed panel alone or as a divider must be purchased separately profile RIC 1384.

TENORE

Parete vasca fissa per combinazioni

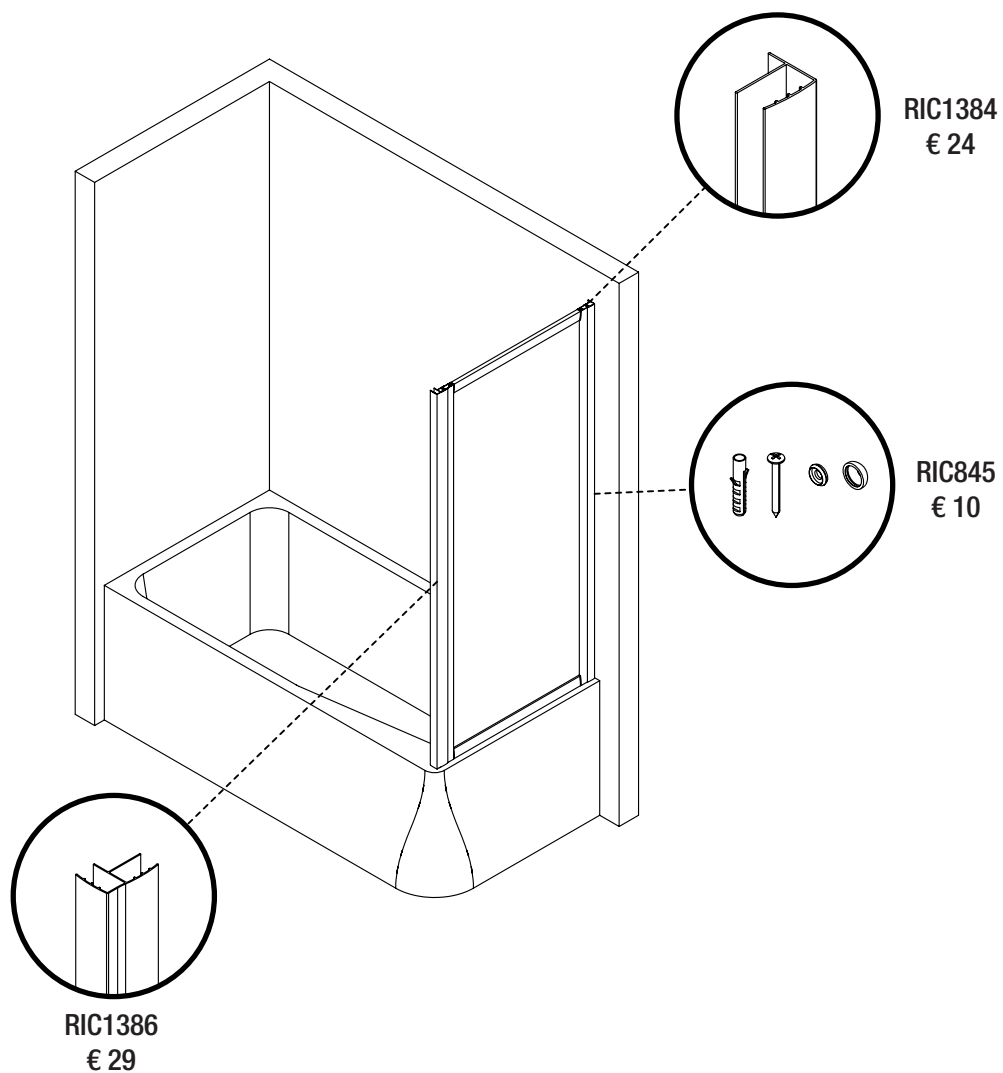

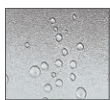

C

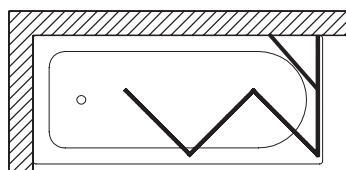

Cabina per vasca a 4 ante
Anta a muro 70 cm.
Ante pieghevoli 45 cm.

4 panels bath screen

Articolo Article	Estensibilità (cm) Extension	Finitura Pannelli Panels Finishing	Codice EAN EAN Code	L1 (€)
B-SI1084C4	70-205	C	8019002042170	315

Prezzi IVA esclusa
Price VAT not included

FIATI

Parete vasca a quattro ante ripieghevoli

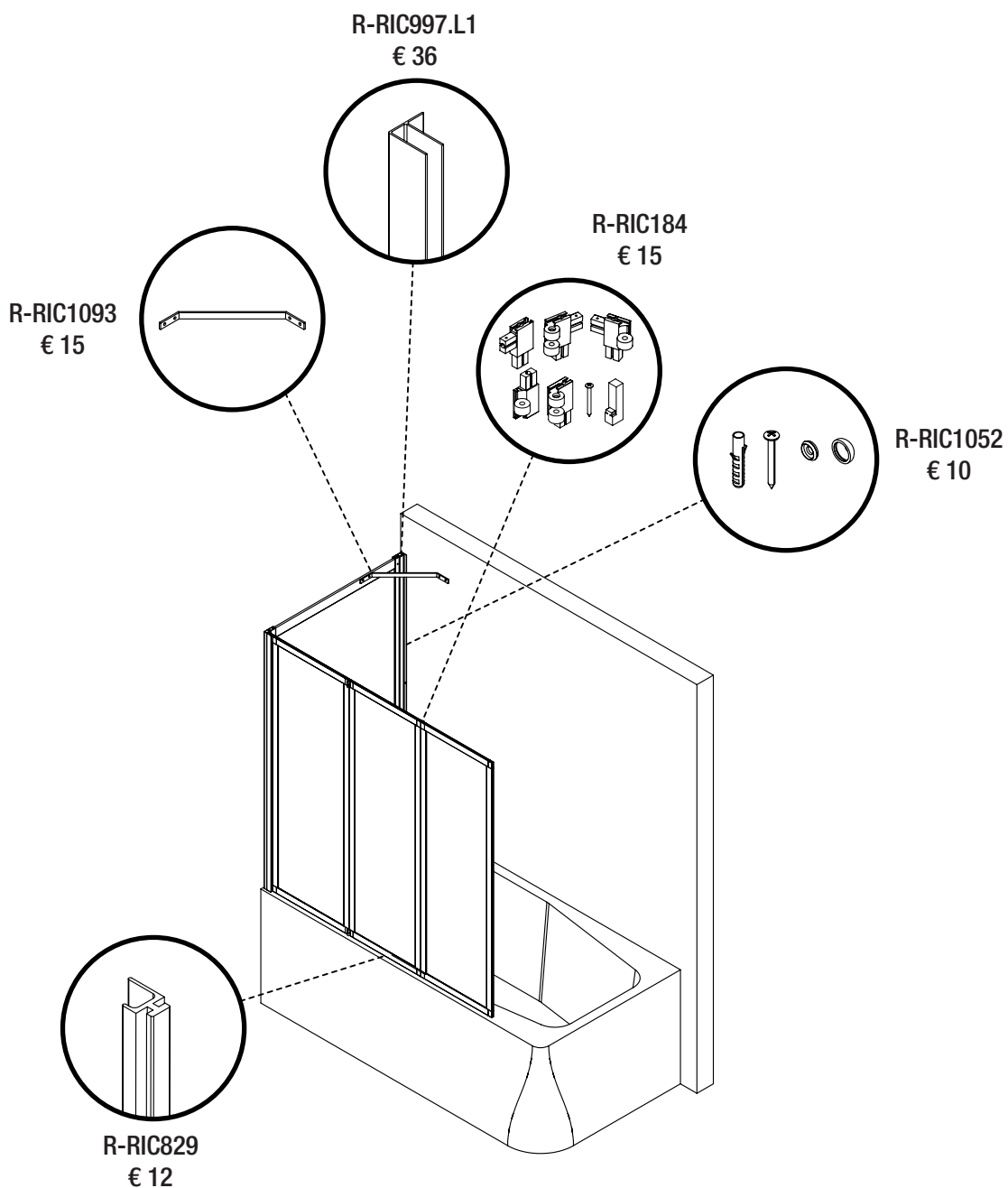

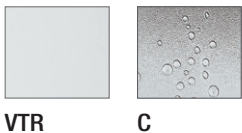

VTR

C

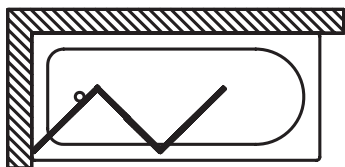

Cabina per vasca a 3 ante ripieghevoli

3 folding panels bath screen

Articolo Article	Estensibilità (cm) Extension	Finitura Pannelli Panels Finishing	Codice EAN EAN Code	L1 (€)	KL (€)
B-SI1084	46-135	VTR	8019002045003	250	315
		C	8019002034038	210	

Prezzi IVA esclusa
Price VAT not included

FIATI

Parete vasca a tre ante ripieghevoli

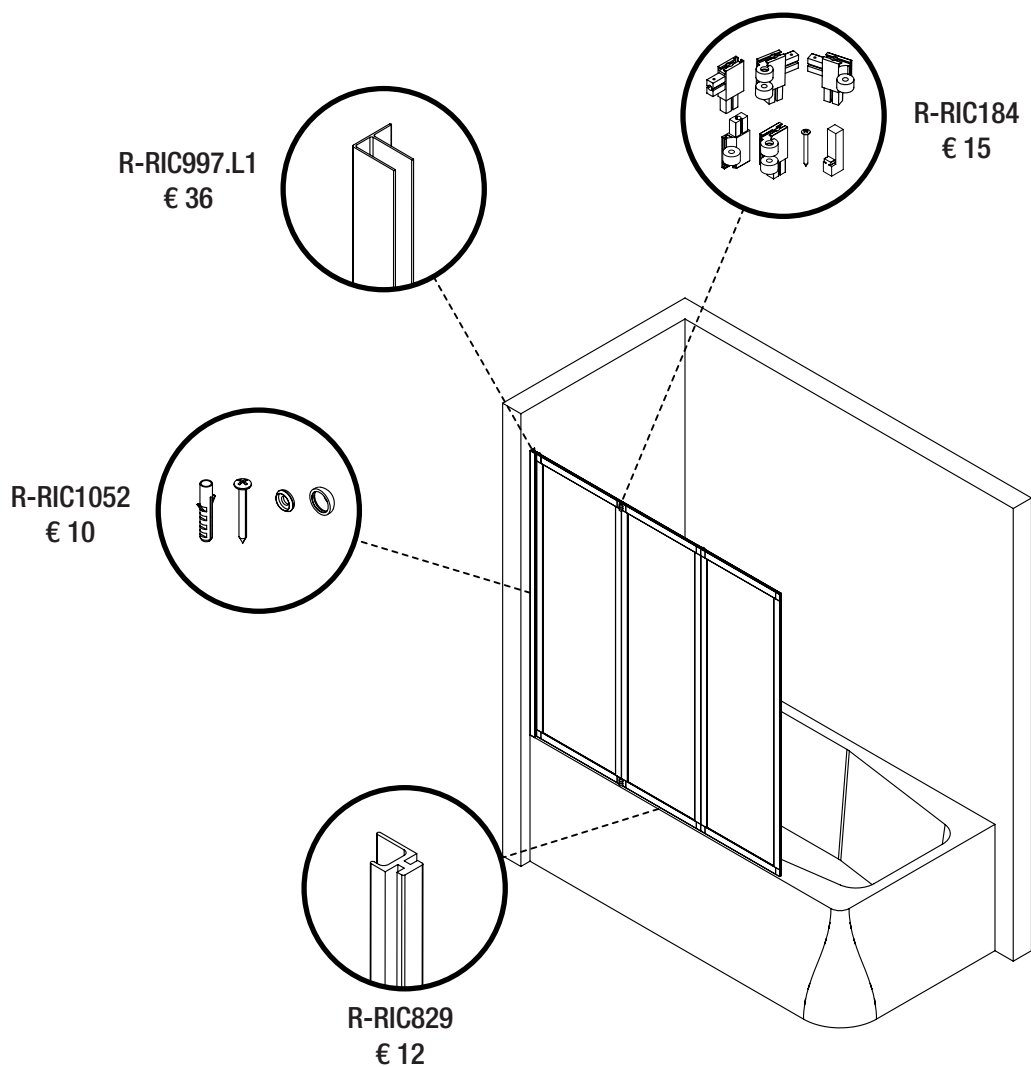

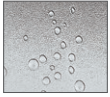
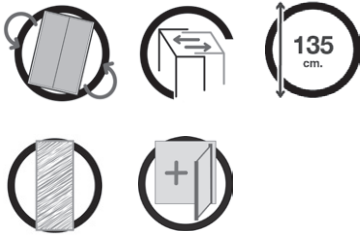

C

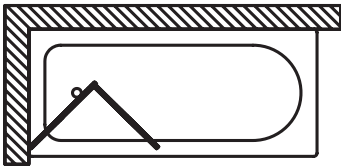

Cabina per vasca a 2 ante

Two panels bath screen

Articolo Article	Estensibilità (cm) Extension	Finitura Pannelli Panels Finishing	Codice EAN EAN Code	L1 (€)
B-SI1085	60-125	C	8019002034045	180

Prezzi IVA esclusa
Price VAT not included

FIATI

Parete vasca a due ante ripieghevoli

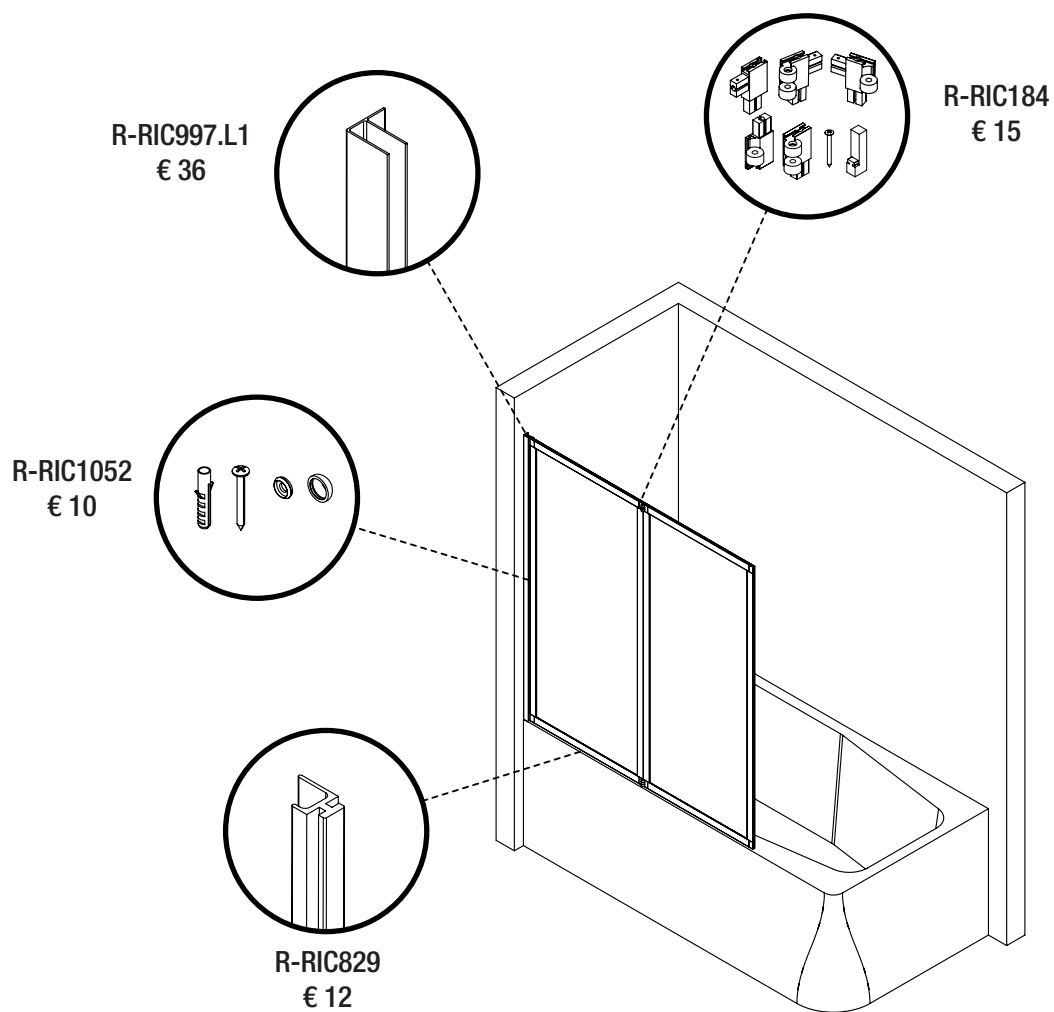

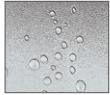
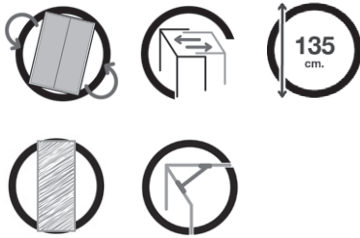

C

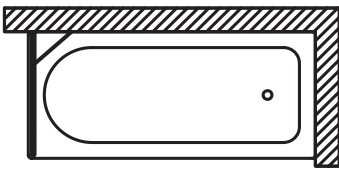

Parete vasca fissa per combinazione
Combinazioni per formare cabine vasca a due lati

Fixed panel bath screen
Suitable for combinations to form two side bath screen

Articolo Article	Estensibilità (cm) Extension	Finitura Pannelli Panels Finishing	Codice EAN EAN Code	L1 (€)
B-SI1090	68-72	C	8019002042194	120

Zanca di sostegno compresa nel prezzo
Hinge support included into the price

Prezzi IVA esclusa
Price VAT not included

Per l'abbinamento con l'articolo B-SI1084CL1 o con B-SI1085CL1 è necessario ordinare a parte il profilo R-RIC1179.L1
To combine this with art. B-SI1084CL1 or B-SI1085CL1 you need to order R-RIC1179.L1 profile apart.

FIATI

Parete vasca fissa per abbinamento

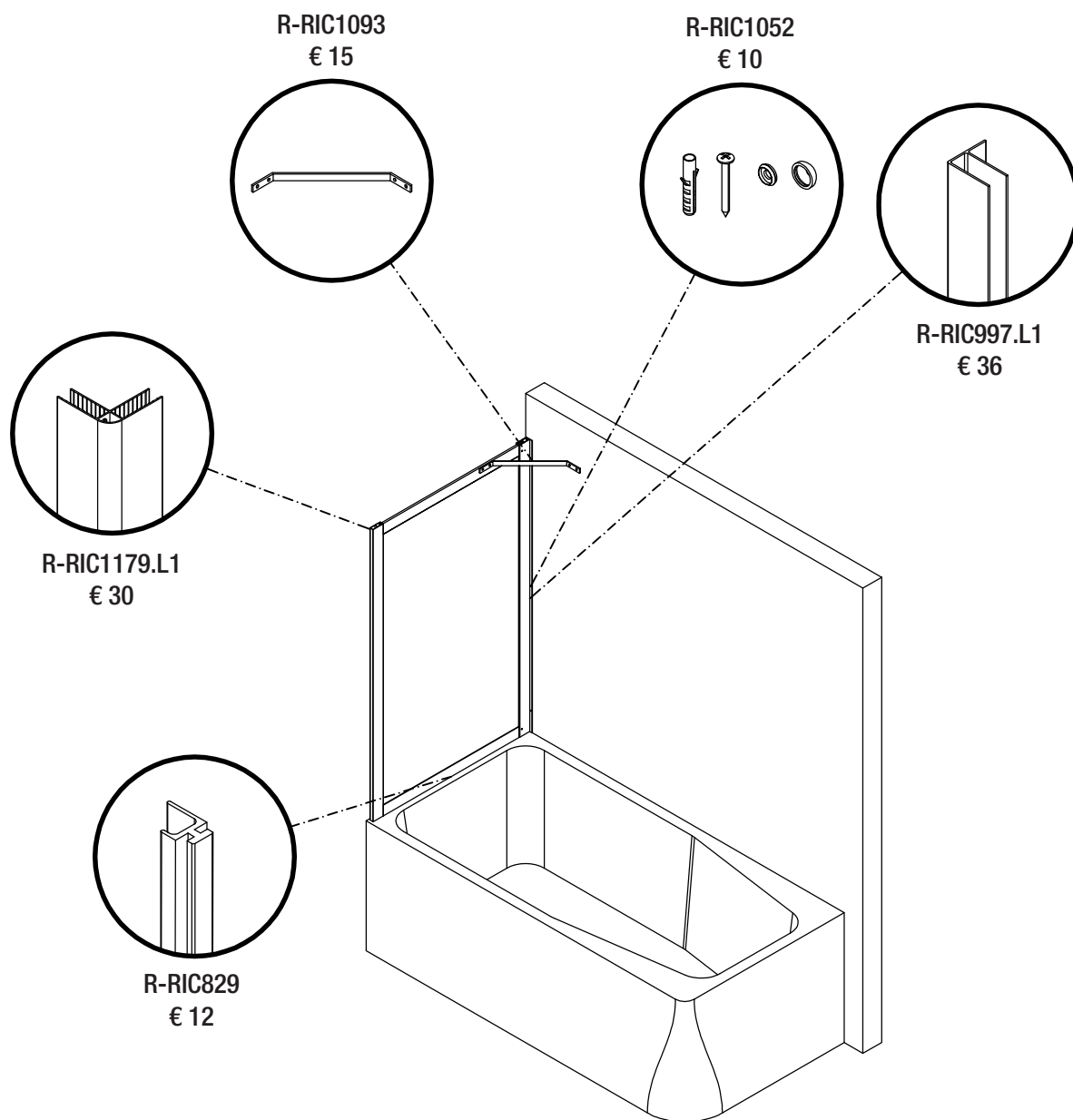

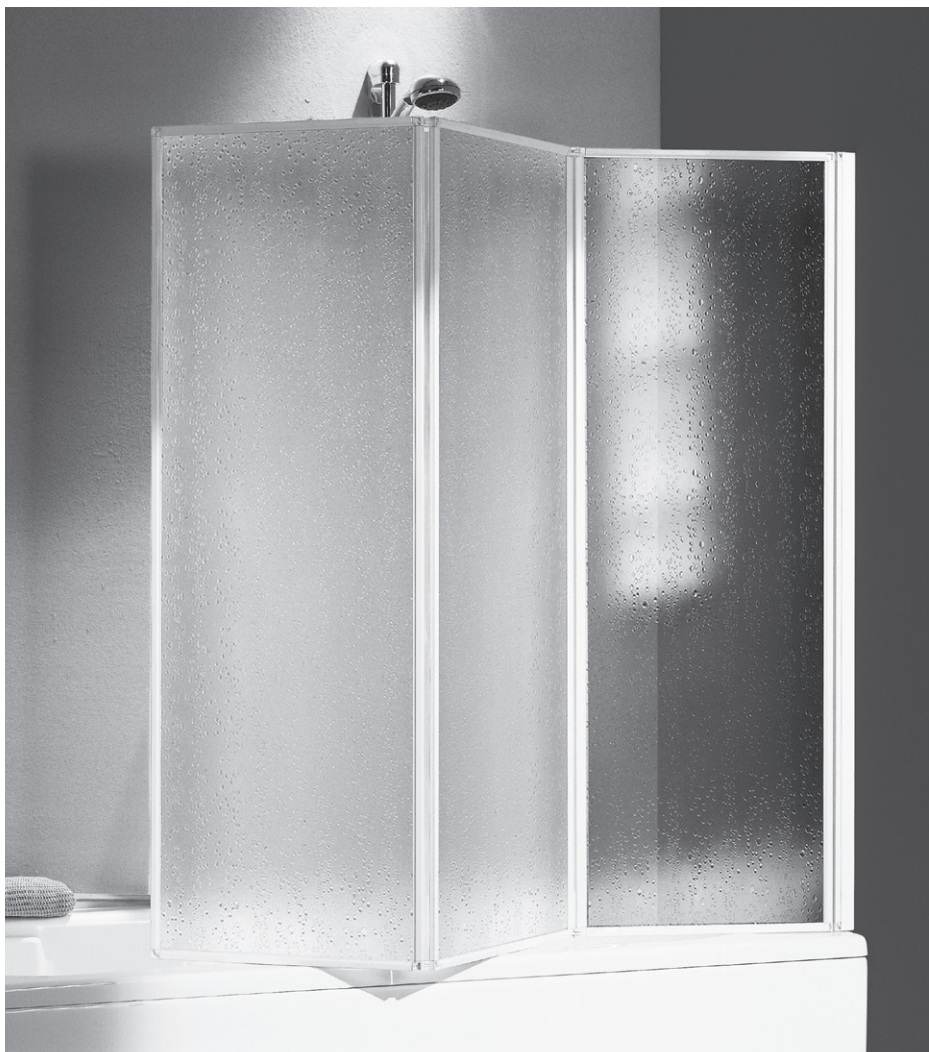
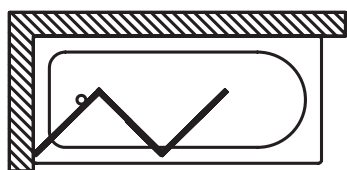
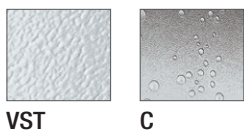
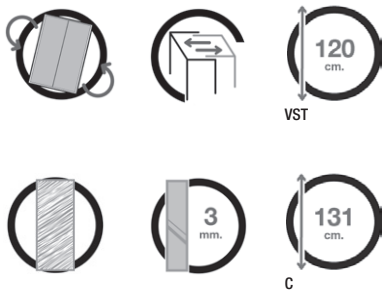

Parete pieghevole a 3 ante per vasca

Three folding panels bath screen

Articolo Article	Estensibilità (cm) Extension	Finitura Pannelli Panels Finishing	Codice EAN EAN Code	L1 (€)
B-SIX300	45-131	VST	8019002068750	190
		C	8019002035554	150

Prezzi IVA esclusa
Price VAT not included

OPERA

Parete vasca a tre ante ripieghevoli

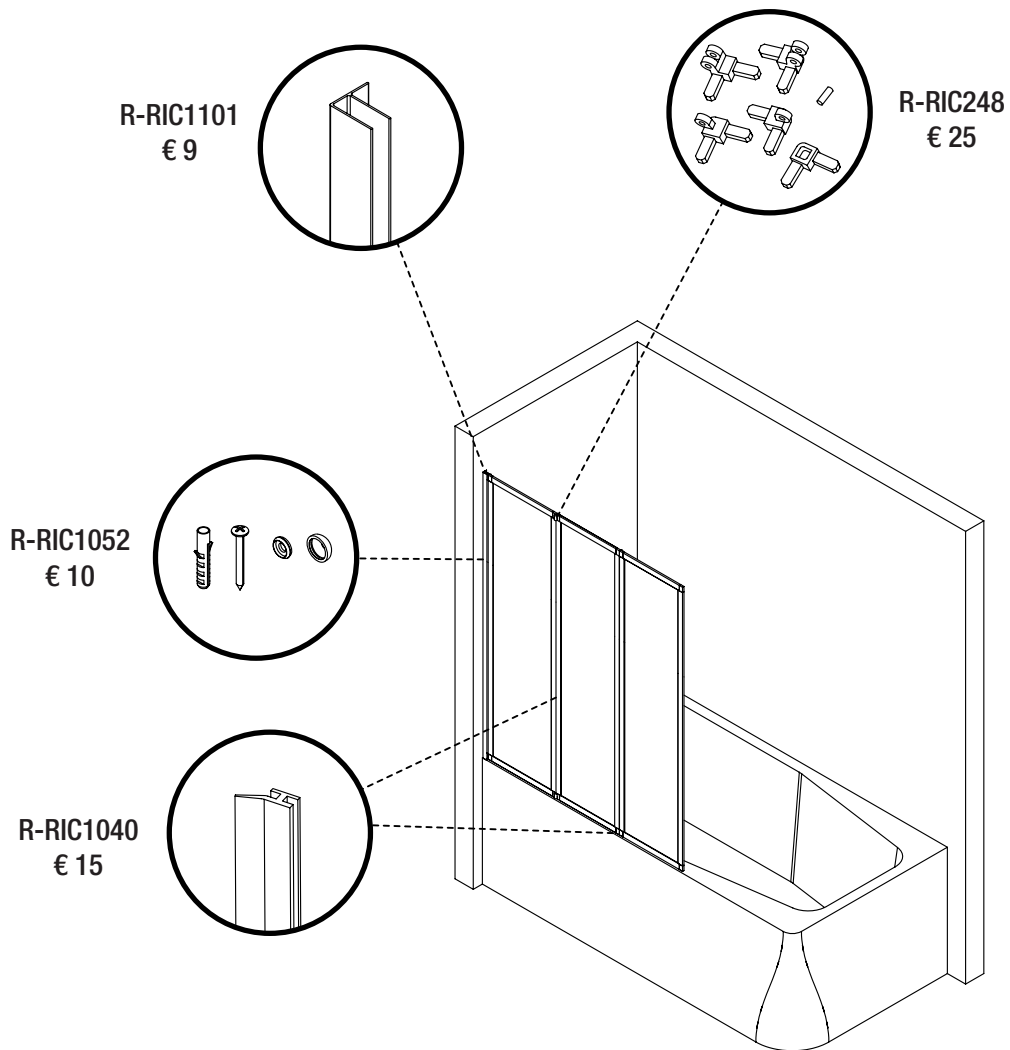

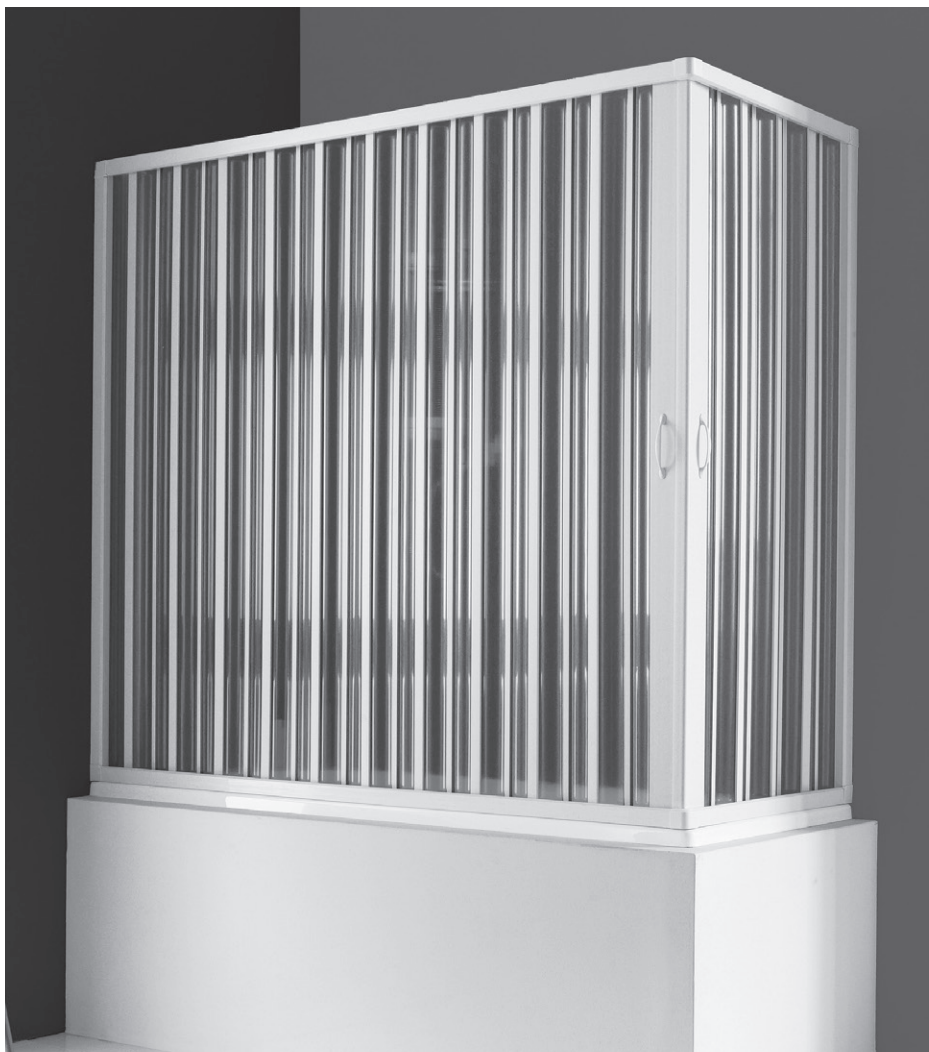
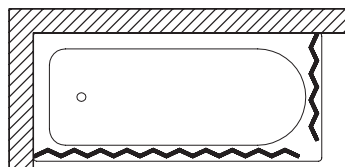

Cabina per vasca a 2 ante

Two panels bath screen

Articolo Article	Estensibilità (cm) Extension	Finitura Pannelli Panels Finishing	Codice EAN EAN Code	L1 (€)
B-PV140	70X160	PVC	8019002054104	315
B-PV141	70X170	PVC	8019002054111	325

Prezzi IVA esclusa
Price VAT not included

Questo prodotto è riducibile alla misura desiderata, basta tagliare il binario ed eliminare le stecche fino ad ottenere la misura desiderata.
This product can be reduced to the desired size, simply cut the track and eliminate the sticks until you get the desired size.

SIPARIO

Parete vasca ad ante ripieghevoli

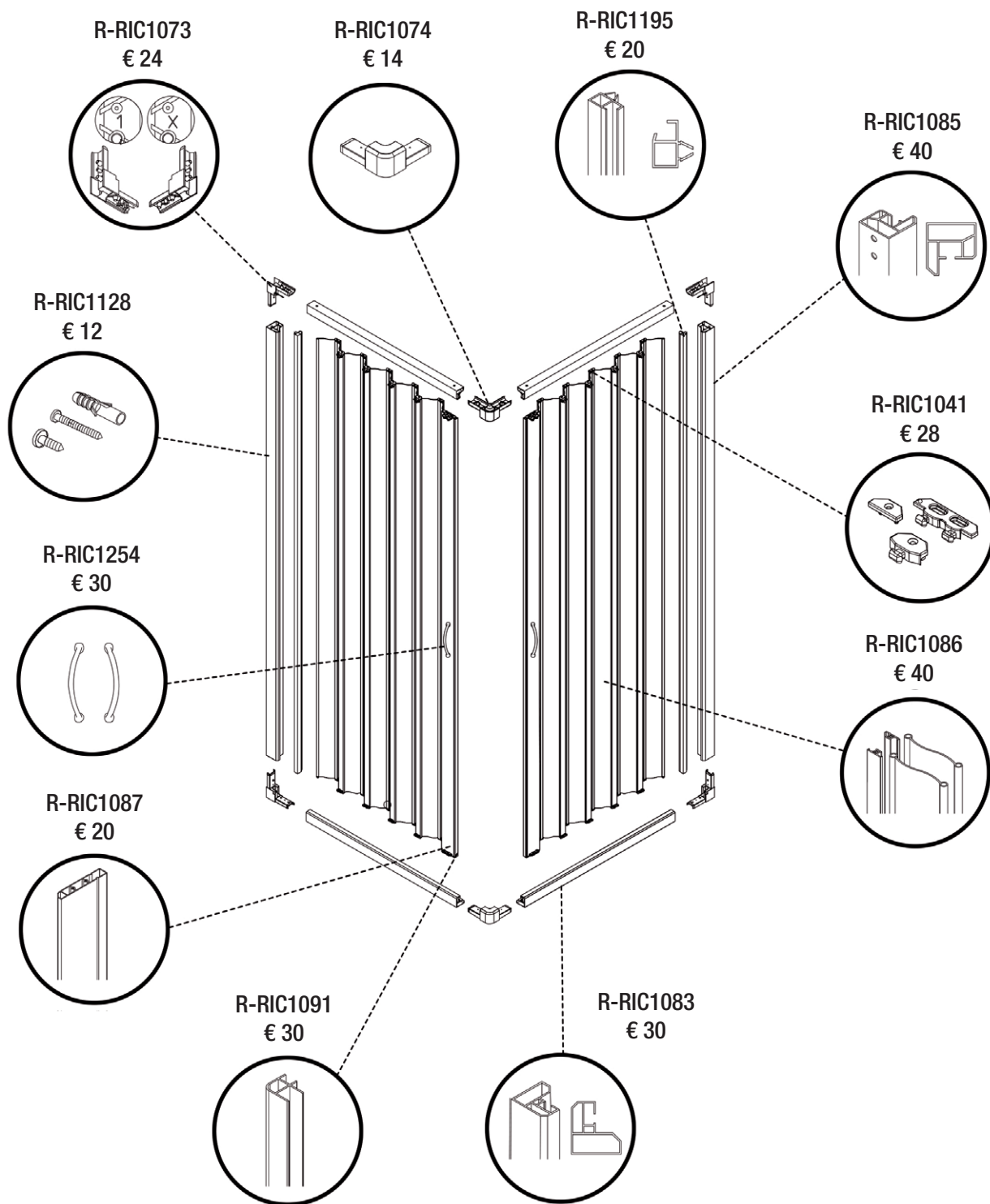

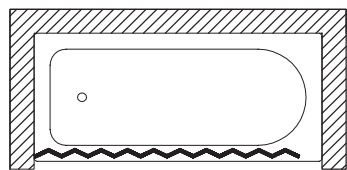

Cabina per vasca a 1 anta

One panel bath screen

Articolo Article	Estensibilità (cm) Extension	Finitura Pannelli Panels Finishing	Codice EAN EAN Code	L1 (€)
B-PV161	160-170	PVC	8019002054135	230

Prezzi IVA esclusa
Price VAT not included

Questo prodotto è riducibile alla misura desiderata, basta tagliare il binario ed eliminare le stecche fino ad ottenere la misura desiderata.
This product can be reduced to the desired size, simply cut the track and eliminate the sticks until you get the desired size.





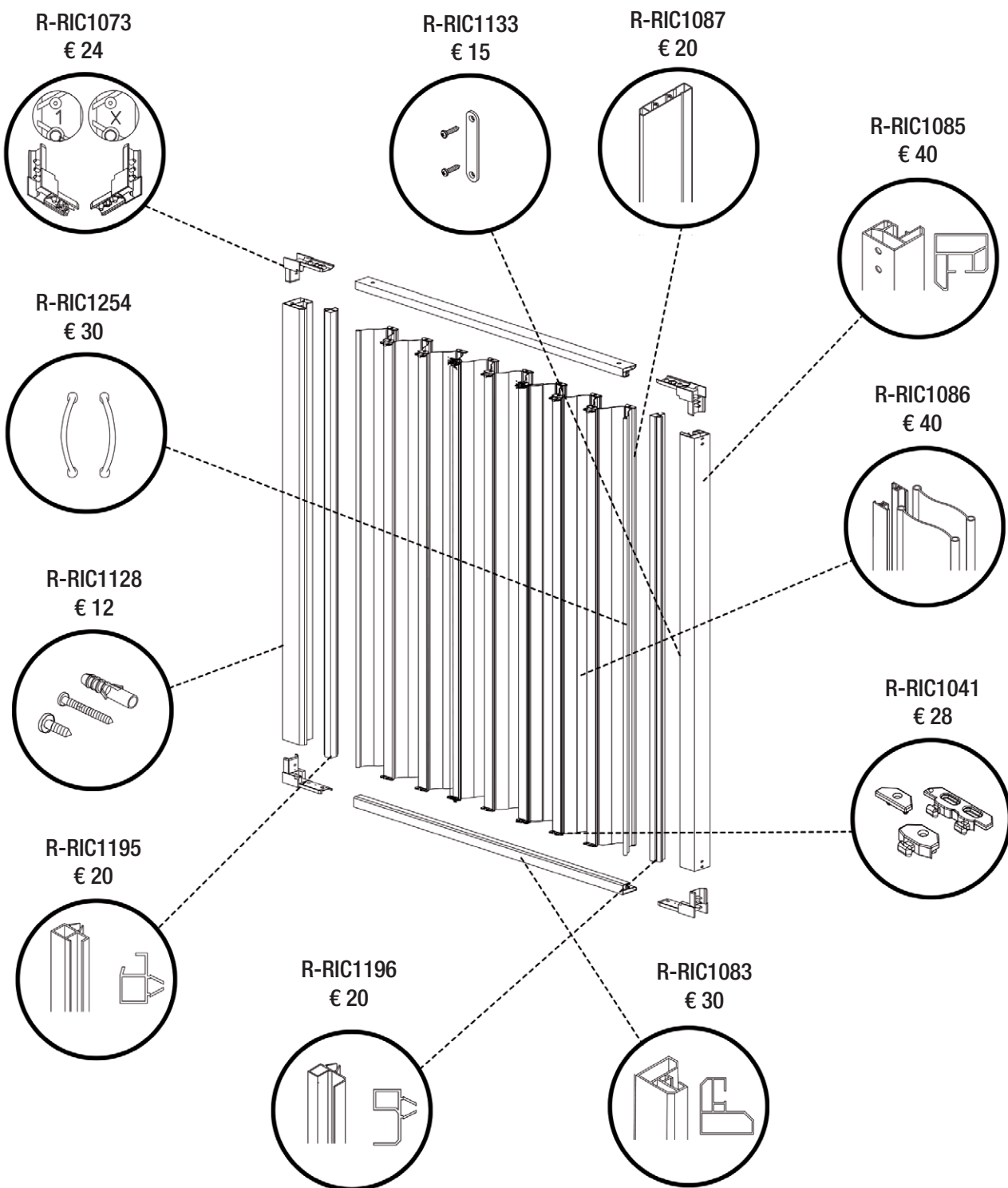





SIPARIO

Parete vasca con anta ripieghevole



LEGENDA SIMBOLI

SYMBOLS

	SIMBOLI	SYMBOLS
	Reversibile per lato apertura	Reversible for opening side
	Scorrimento a cuscinetto	Sliding system on bearing
	Scorrimento a rotellina	Sliding system on wheels
	Frangiflutto o profilo di base	Breakwater or profile
	Guarnizione inferiore di tenuta con gocciolatoio	Lower gasket
	Chiusura magnetica ammortizzata	Magnetic closure with absorber
	Chiusura magnetica	Magnetic closure
	Maniglia	Handle
	Pomello	Knob
	Cerniera	Hinge
	Zanca di sostegno	Fixing device

	SIMBOLI	SYMBOLS
	Estensibilità	Reversible for opening side
	Profilo di compensazione	Sliding system on bearing
	Abbinamento con parete fissa	Sliding system on wheels
	Pannelli in cristallo	Breakwater or profile
	Pannelli in polystirene	Lower gasket
	Soffione	Magnetic closure with absorber
	Altezza totale cabina	Magnetic closure
	Doccino a X funzioni	Handle
	Guarnizione fermavetro	Knob
	Non reversibile	Hinge
	Adatto a portatori di handicap	Fixing device

SIRO



www.siro.it
siro@siro.it